

DONNERSTAG, 26. JANUAR 2023

3. WORKSHOP

UFERPARKANLAGE IM BRÜGGMOOS

«TESTPLANUNG»

MOFA

&

TEAM

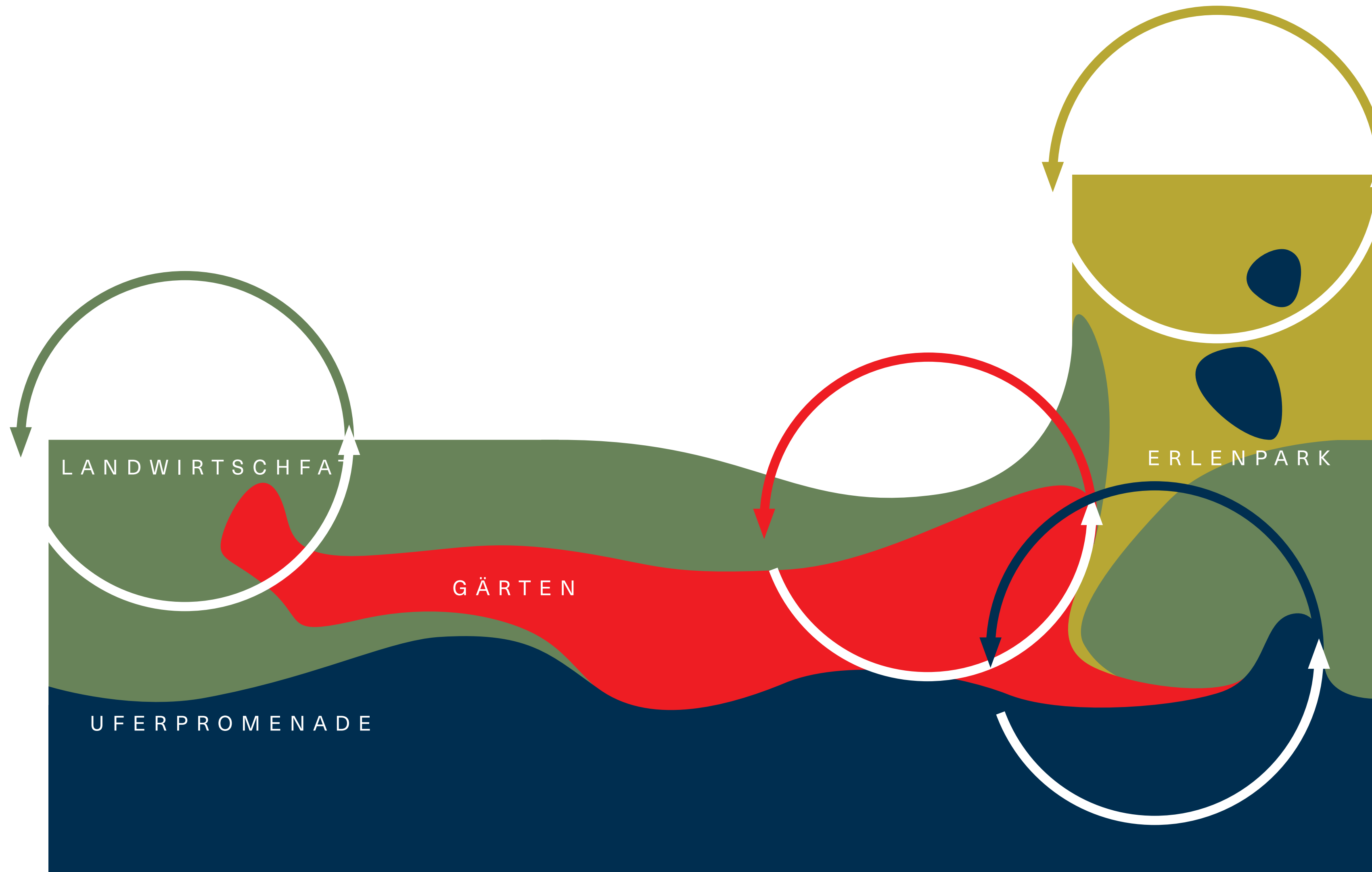

KONZEPTDIAGRAMM

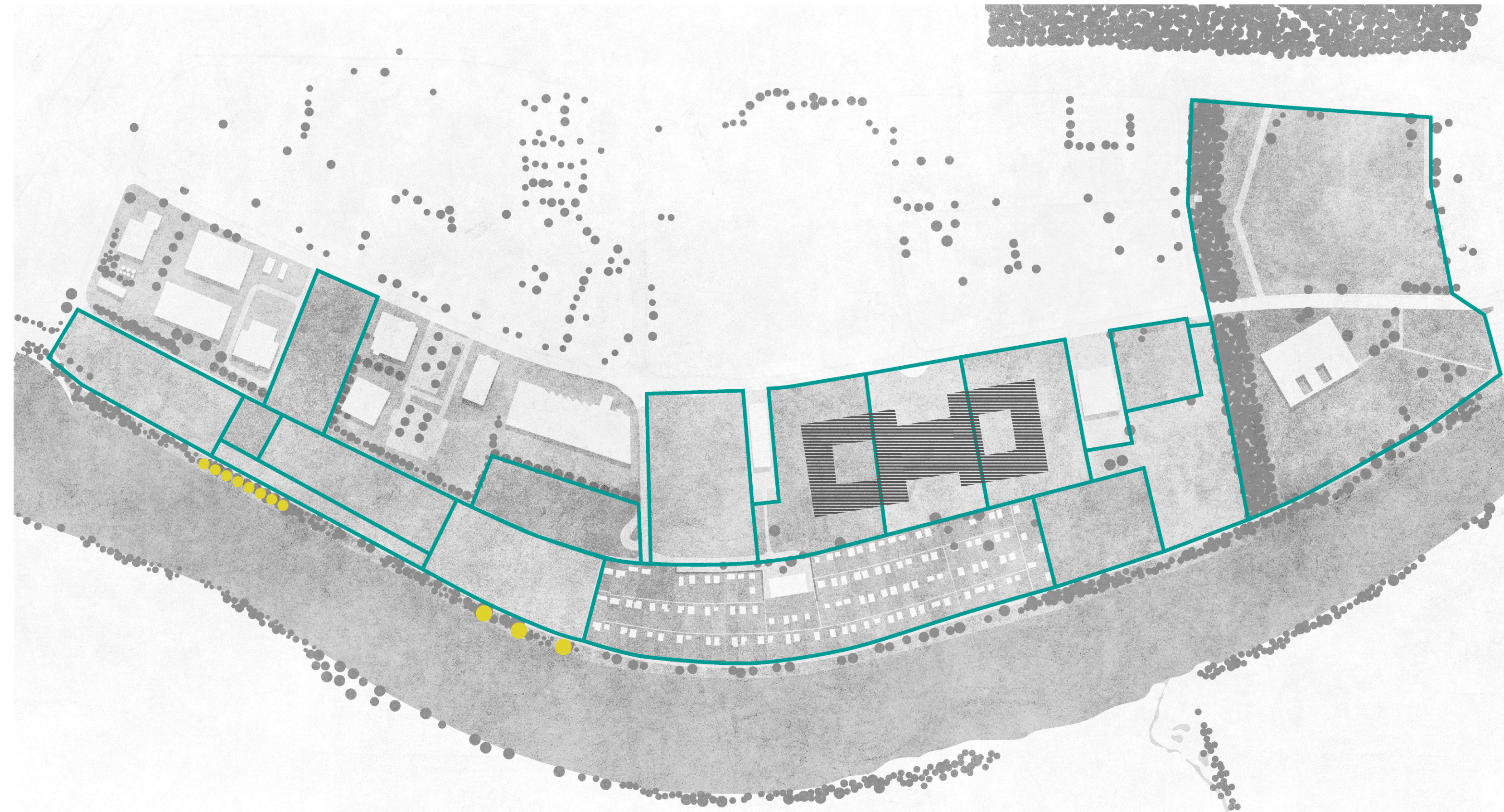

- PARZELLENGRENZEN
- WERTVOLLER BAUMBESTAND
- SPITAL GEPLANT

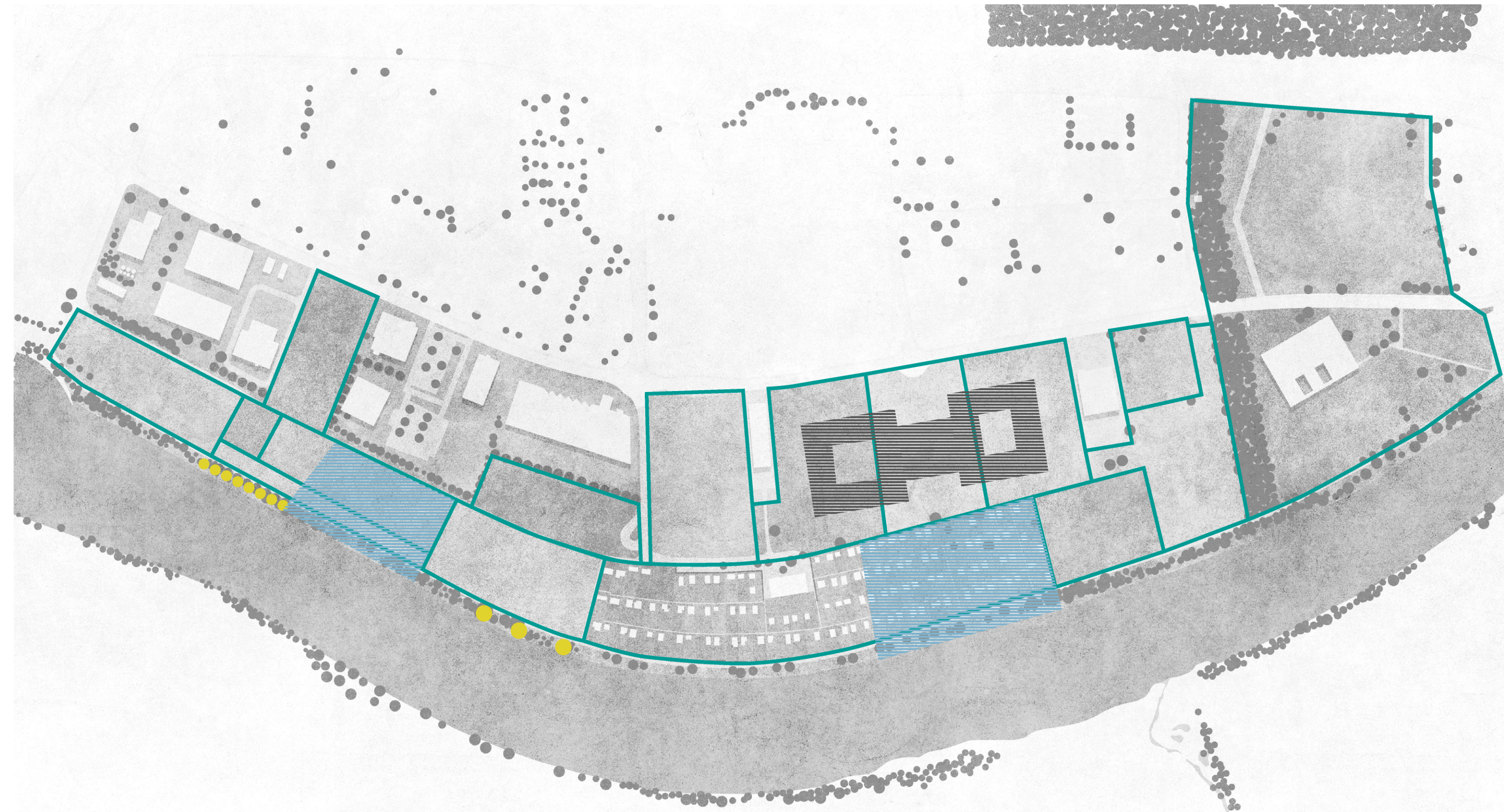

- PARZELLENGRENZEN
- WERTVOLLER BAUMBESTAND
- SPITAL GEPLANT
- POSITION LANDSCHAFTSFENSTER

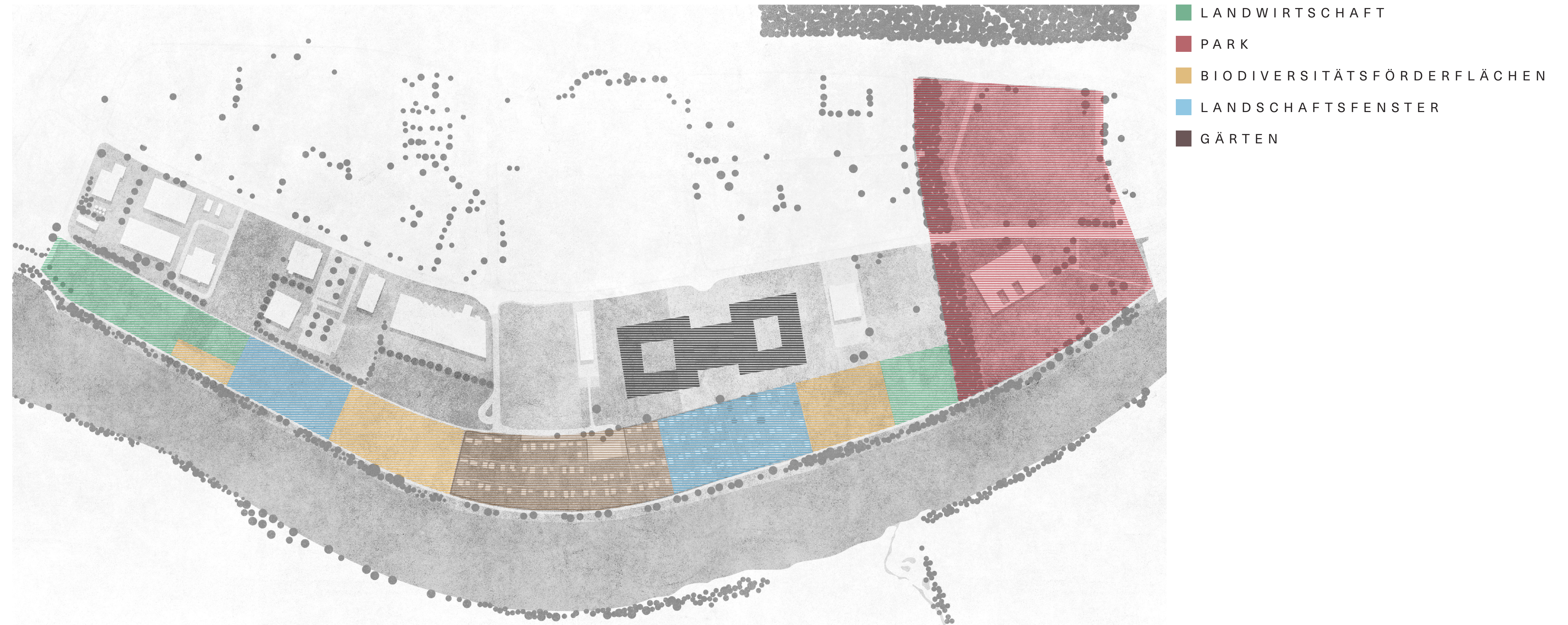

ZONIERUNG DER PARKLANDSCHAFT

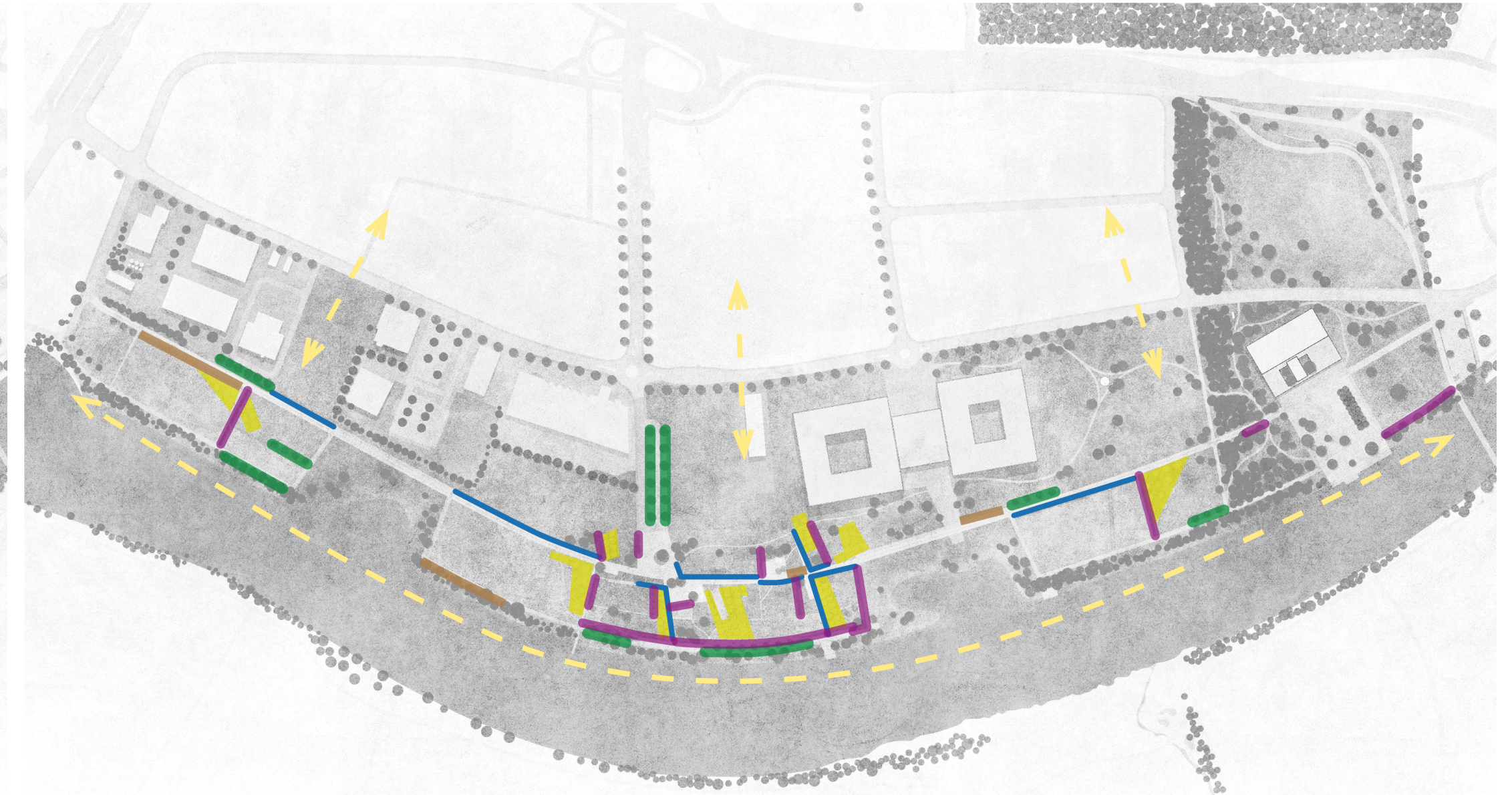
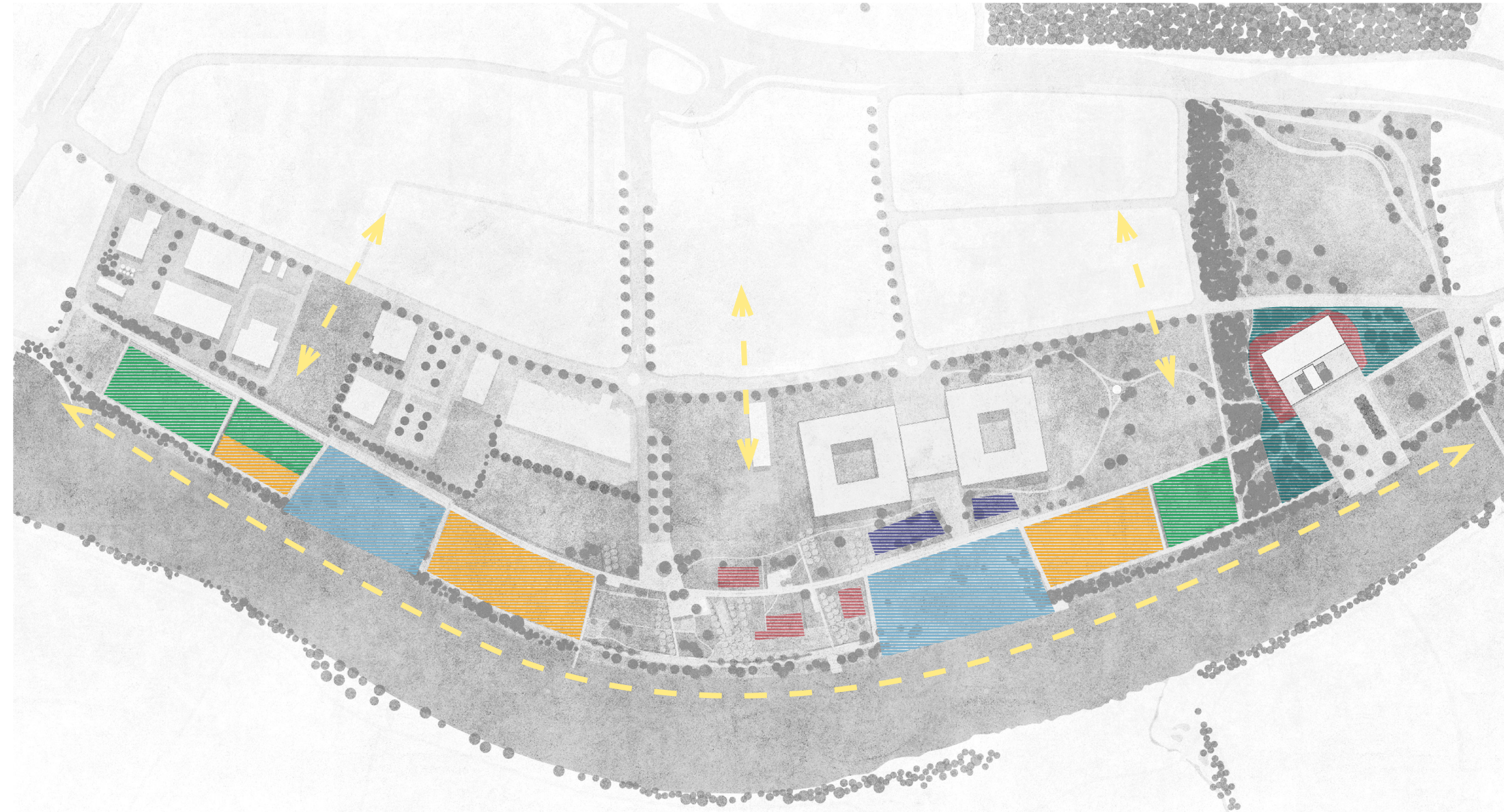

- LANDWIRTSCHAFT
- LANDSCHAFTSFENSTER
- BFF
- WILDBLUMENWIESE
- WEIHER
- WALDVERDICHTUNG
- ← → VERNETZUNG

- MAUERN
- HECKEN
- STREUOBSTWIESE
- RETENTION
- ALLEE



SITUATIONSPLAN UFERPARK I.O. M 1:1000

GEGENWÄRTIGE SITUATION

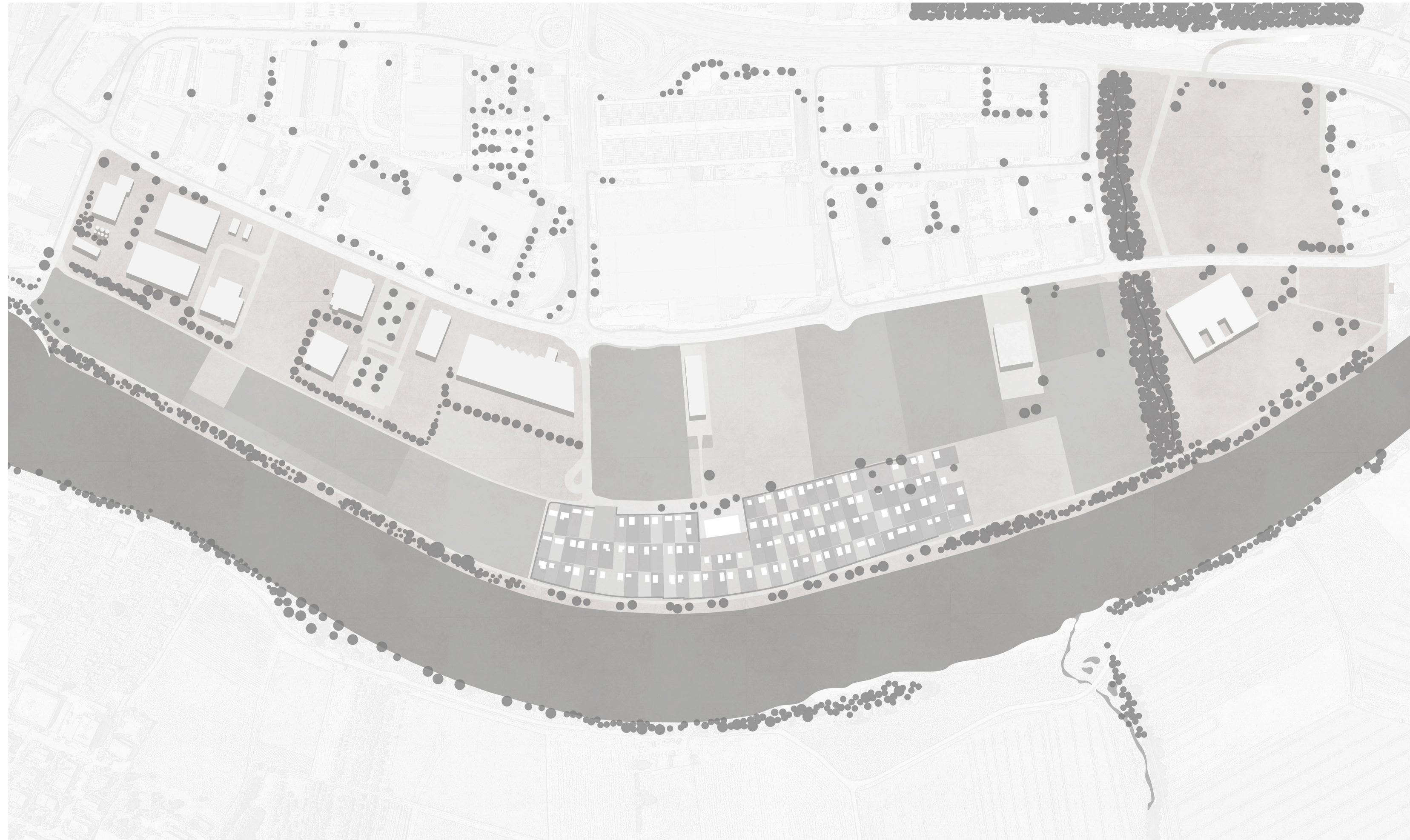

IST ZUSTAND



REALISIERUNG BIS 2026/27

- ERLENPARK
- VELOROUTE
- PARK-WEGENETZ
- LANDSCHAFTSFENSTER



REALISIERUNG BIS 2028/29

- SPITALNEUBAU
- SPITAL-PARK
- VERDICHTUNG WEGENETZ
- TRANSFORMATION FELDER UND GÄRTEN



REALISIERUNG AB 2029

- TRANSFORMATION FELDER UND GÄRTEN
- VERDICHTUNG SEKUNDÄRSTRUKTUREN



SITUATIONSPLAN I.O. M 1:500



VISUALISIERUNG TREPPENANLAGE ERLENPARK





- KAFFEE TRINKEN, UMZIEHEN, SANDWICH ESSEN
- BEGEGNEN, SITZEN, PINGPONG SPIELEN, KAUFEN/VERKAUFEN
- SONNENBADEN, SCHWIMMEN, PLANTSCHEN, DUSCHEN, BEOBACHTEN
- FUSSBALL SPIELEN, PICKNICKEN, LIEGEN, DRACHEN FLIEGEN
- SPAZIERENGEHEN, RUHE FINDEN
- SPIELEN, KLETTERN, GRILLIEREN
- ANKOMMEN, PARKIEREN



- BUCHE, FELD-ULME, SPITZAHORN, ESCHEN, WINTERLINDE, HÄNGBIRKE, TRAUBENEICHE, TRAUBENKIRSCHEN
- SCHWARZERLE, BAMBUSERLE, GESCHLITZTBLÄTTRIGE SCHWARZERLE
- WALDFÖHRE, SCHWARZFÖHRE
- ZITTERPAPPEL
- TRAUERWEIDE
- STIELEICHE

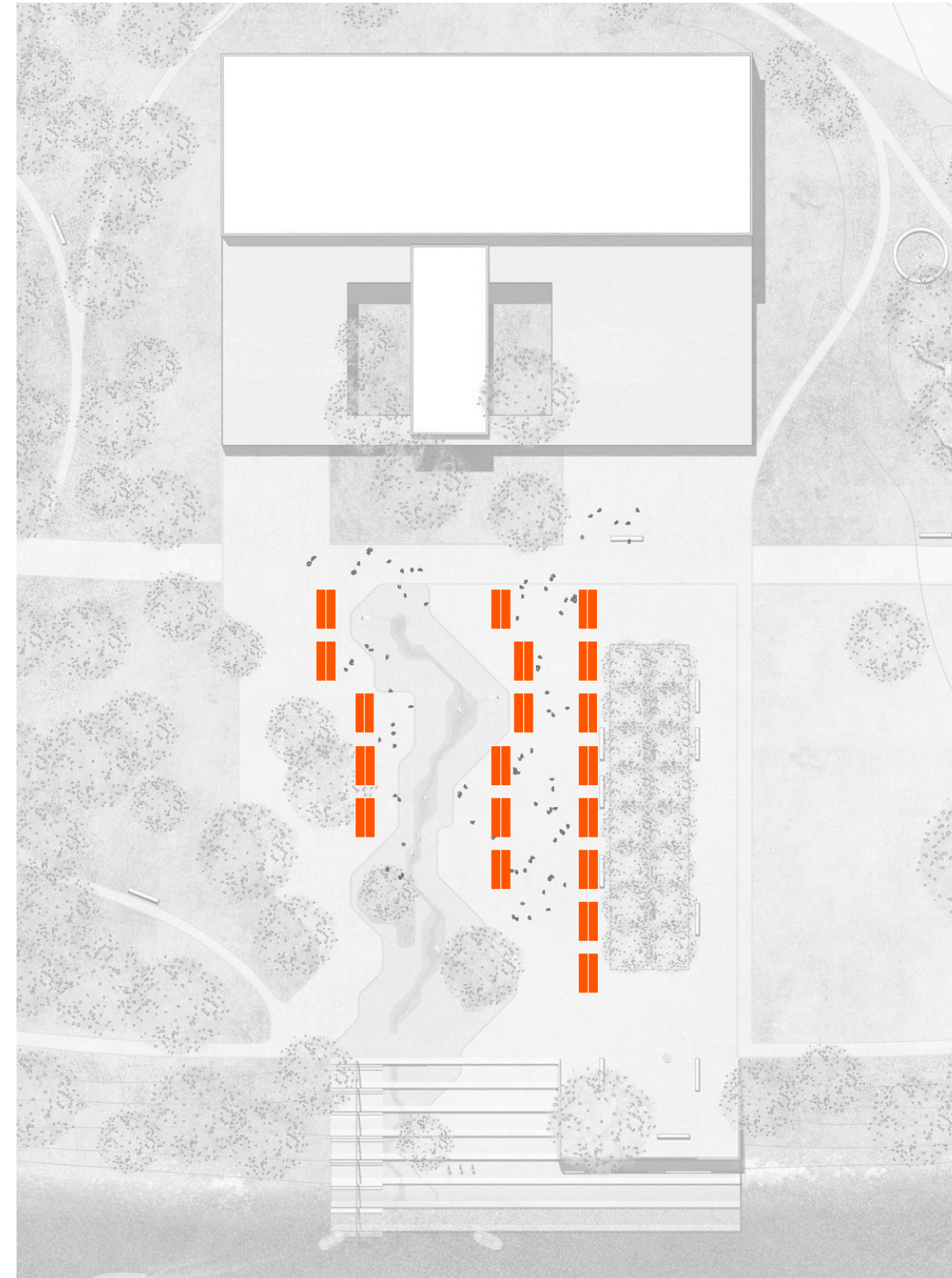

WOCHENMARKT

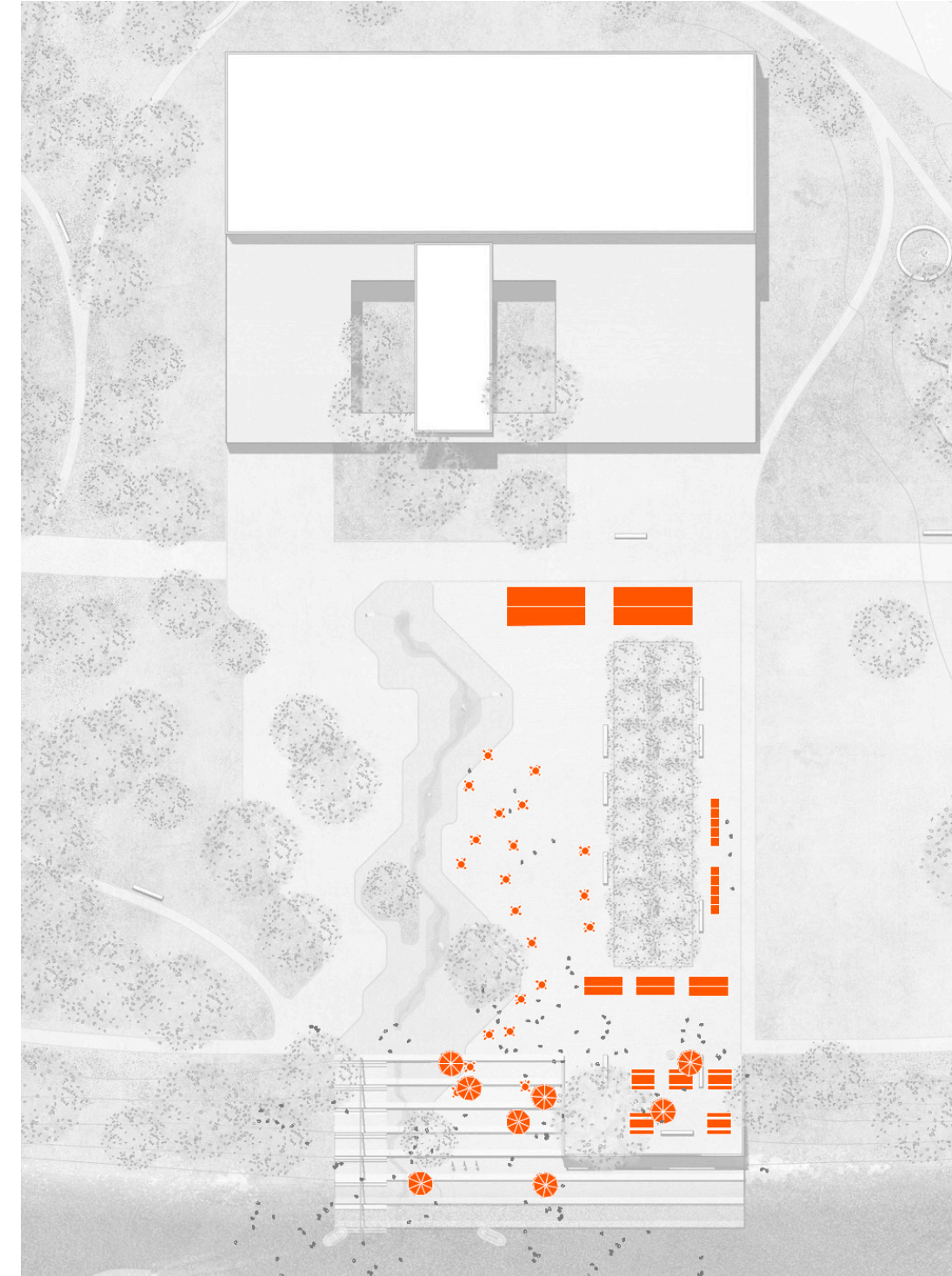

AARESCHWIMM

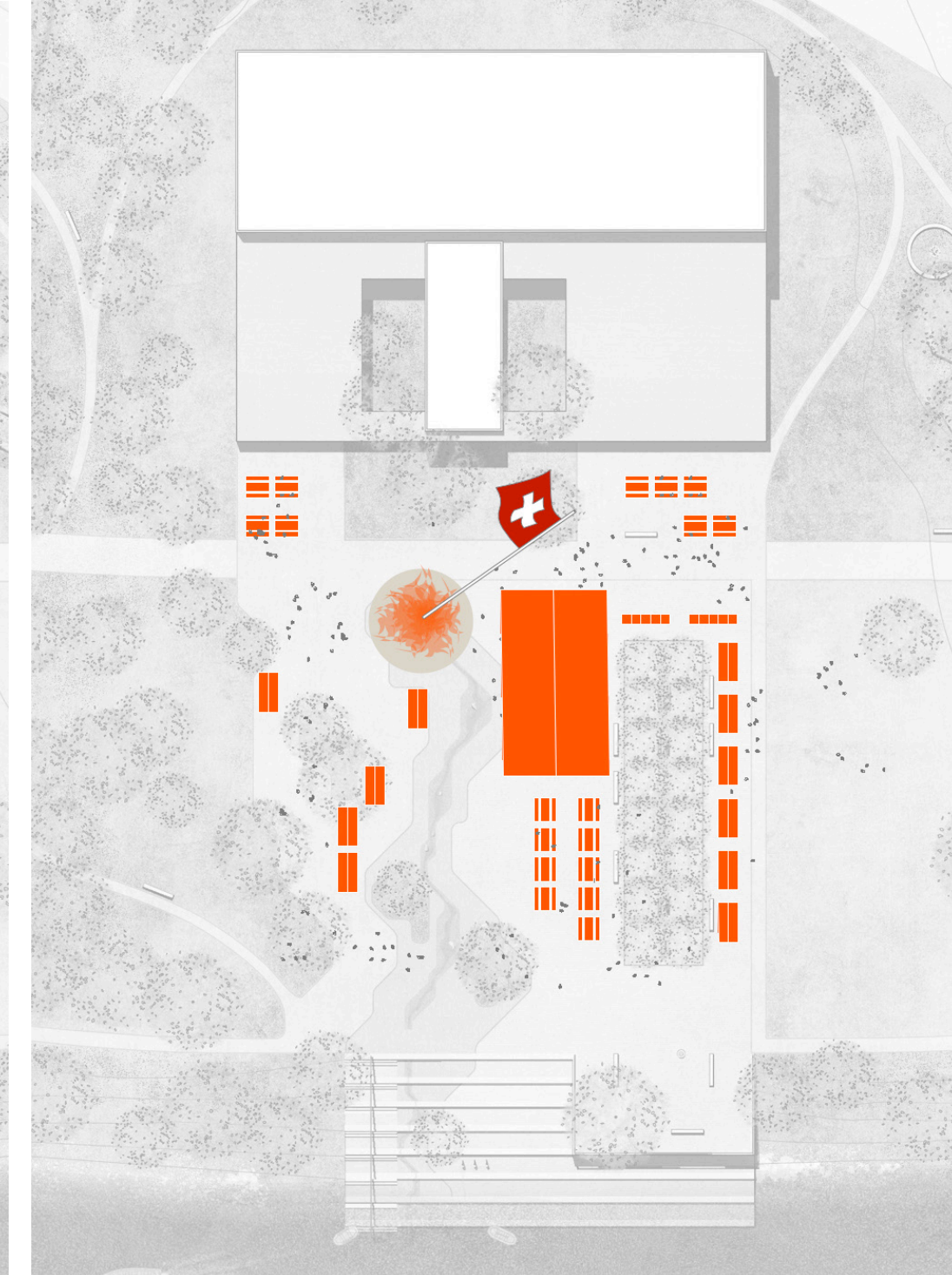

1. AUGUST

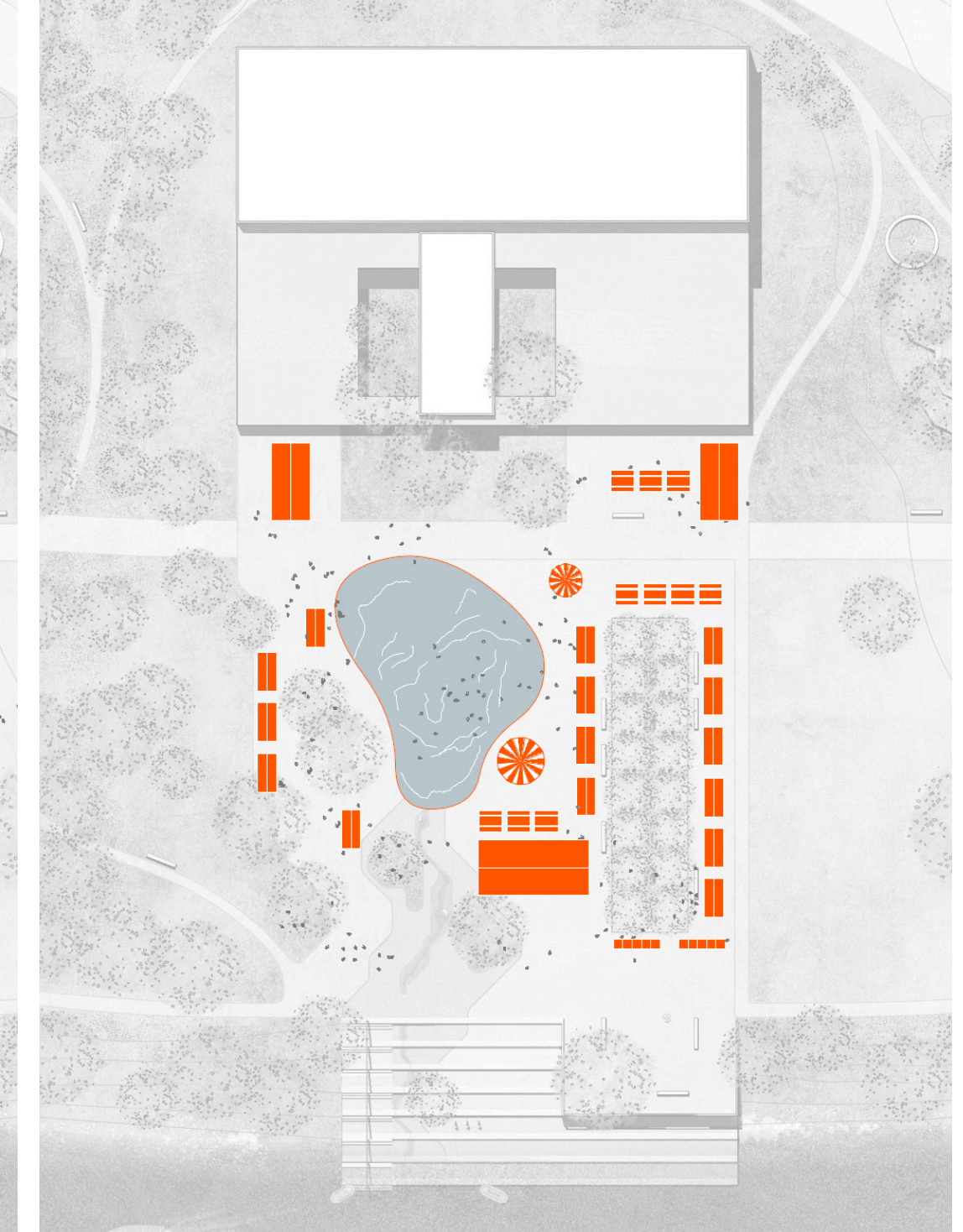

WEIHNACHTSMARKT

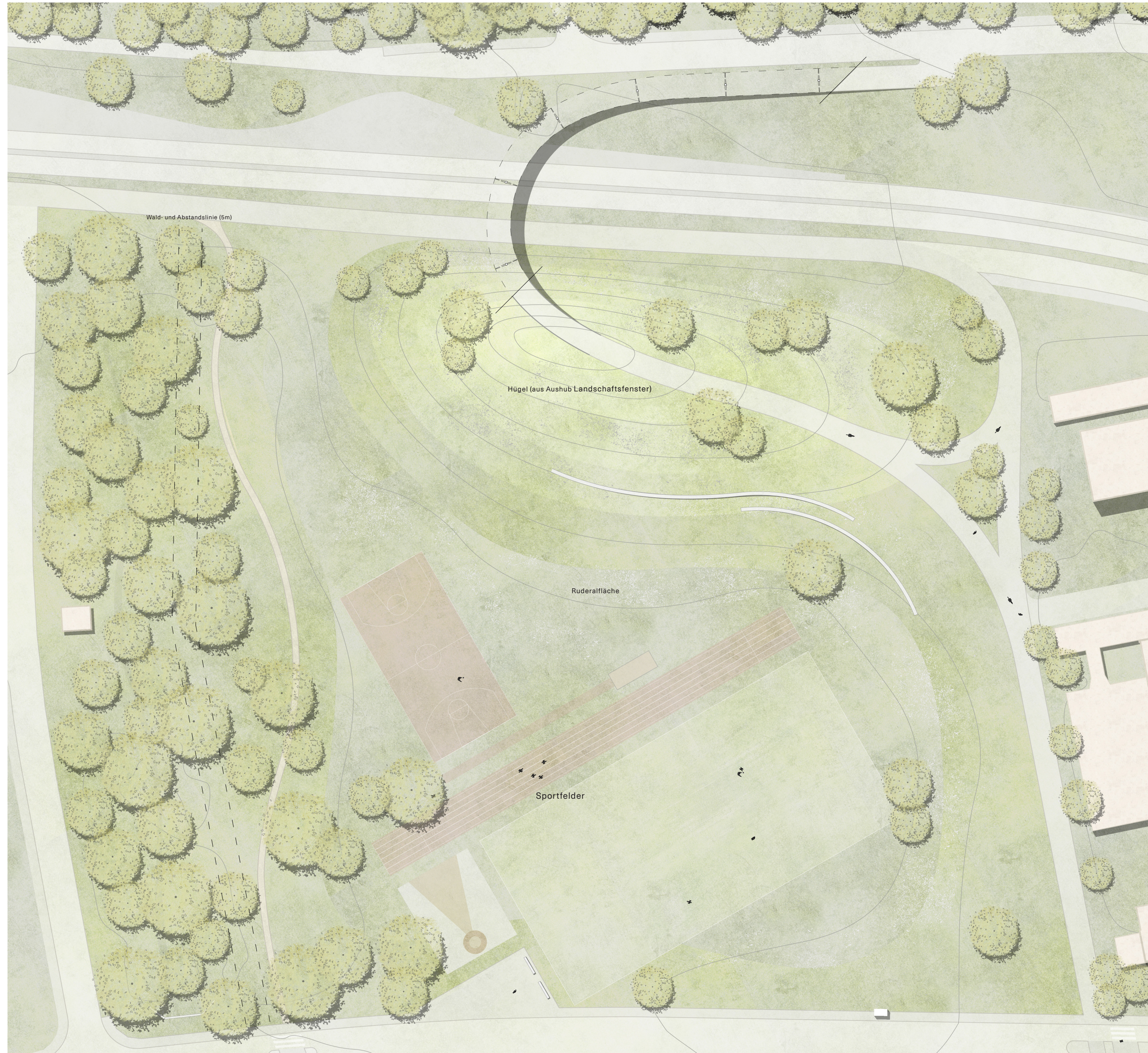



TERRAINVERSCHIEBUNG

- NIEDRIGWASSER_Z426.2MÜM
- MITTELWASSER_Z427MÜM
- KLEINESHOCHWASSER_Z428.2MÜM
- HÖCHSTESHOCHWASSER_Z428.94MÜM

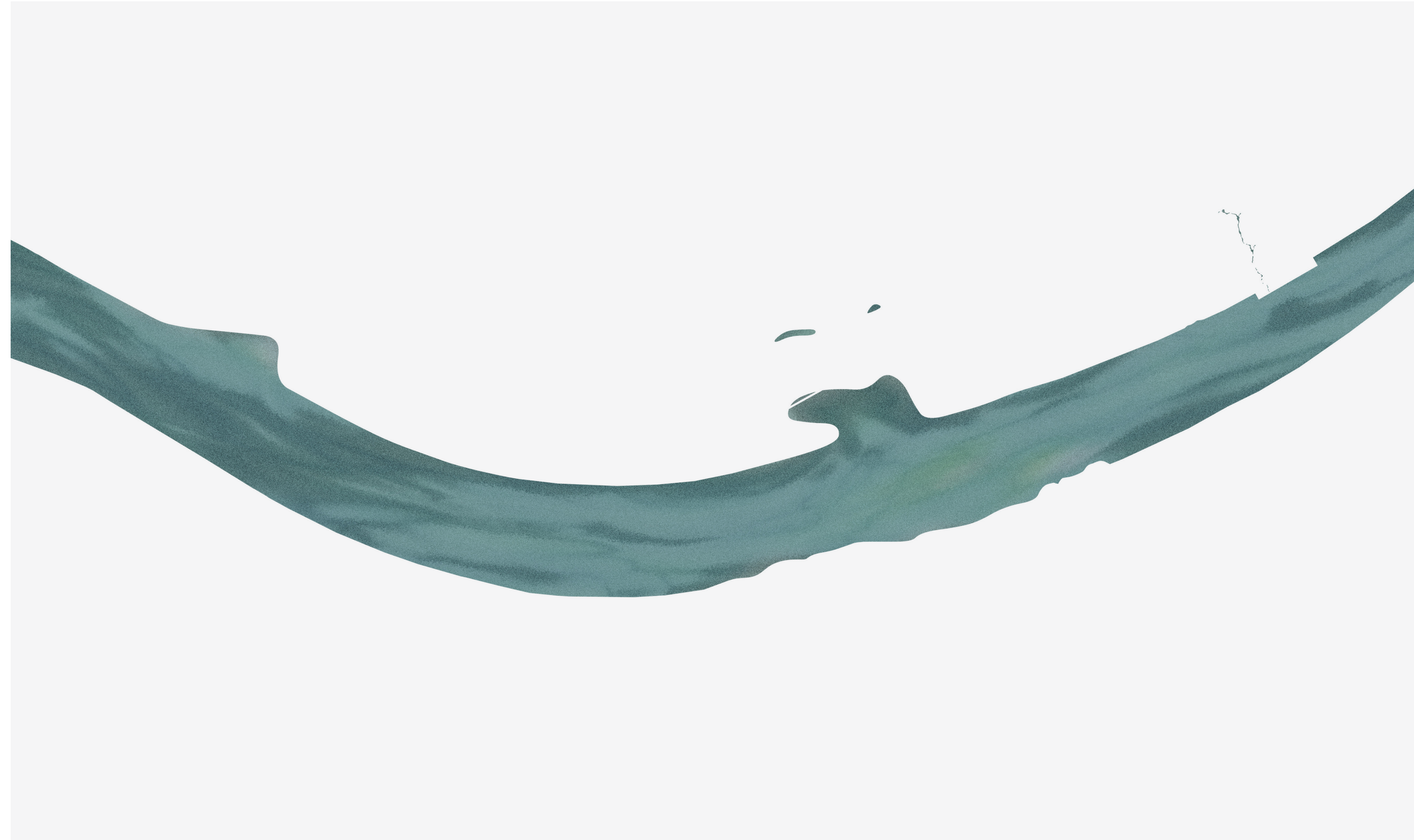

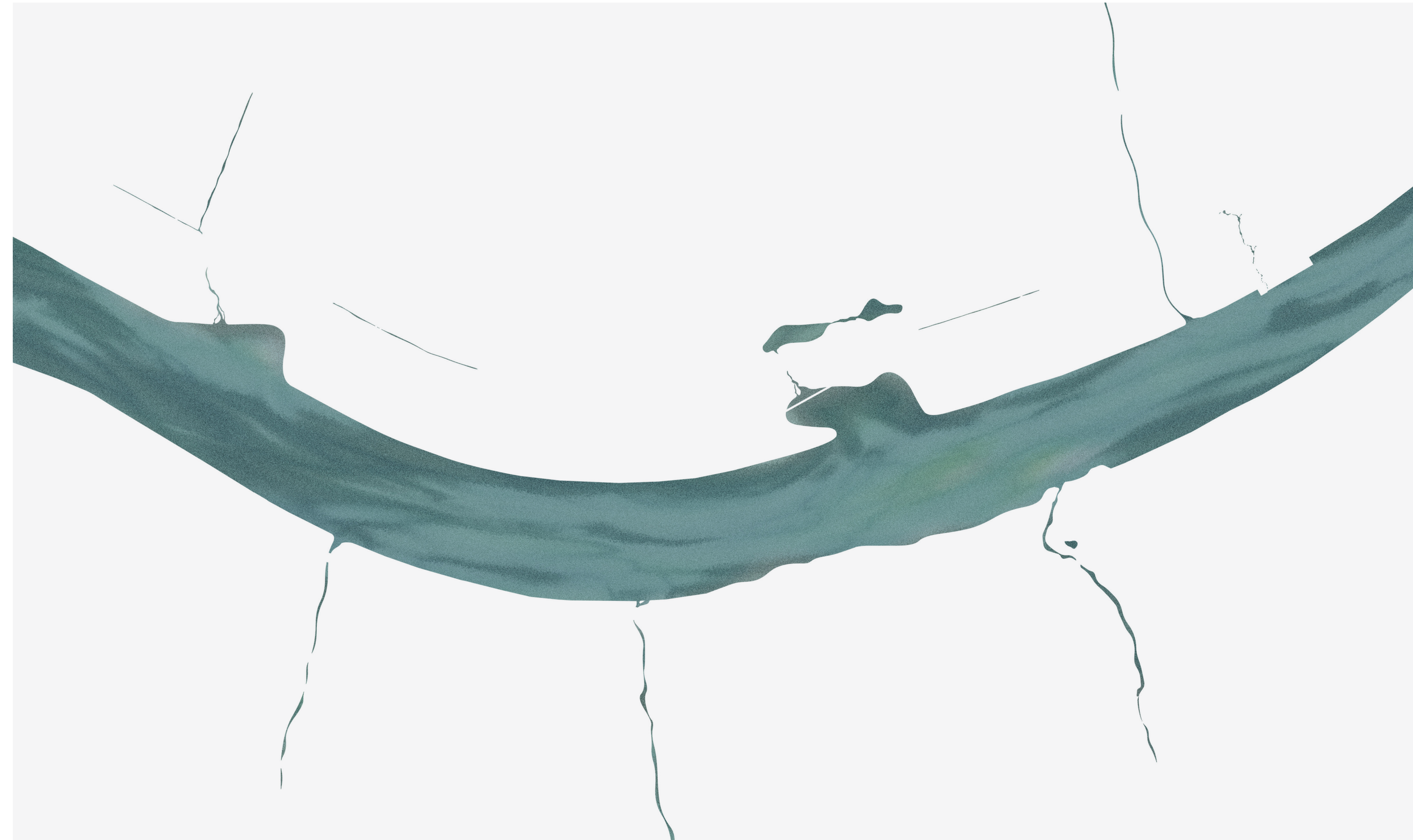

- NIEDRIGWASSER_Z426.2MÜM
- MITTELWASSER_Z427MÜM
- KLEINESHOCHWASSER_Z428.2MÜM
- HÖCHSTESHOCHWASSER_Z428.94MÜM

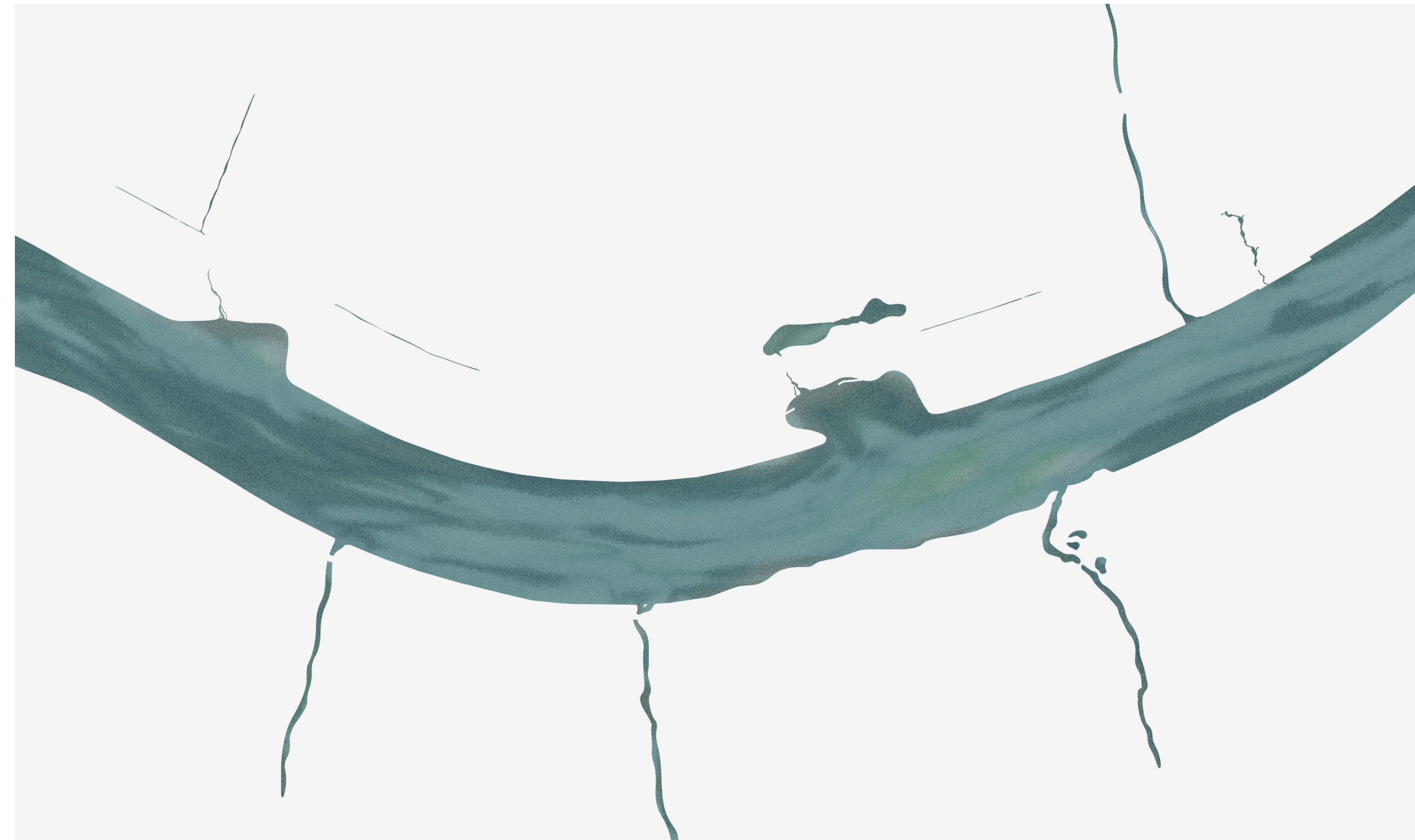

- NIEDRIGWASSER_Z426.2MÜM
- MITTELWASSER_Z427MÜM
- MITTLERES HOCHWASSER_Z428.2MÜM
- HÖCHSTES HOCHWASSER_Z428.94MÜM

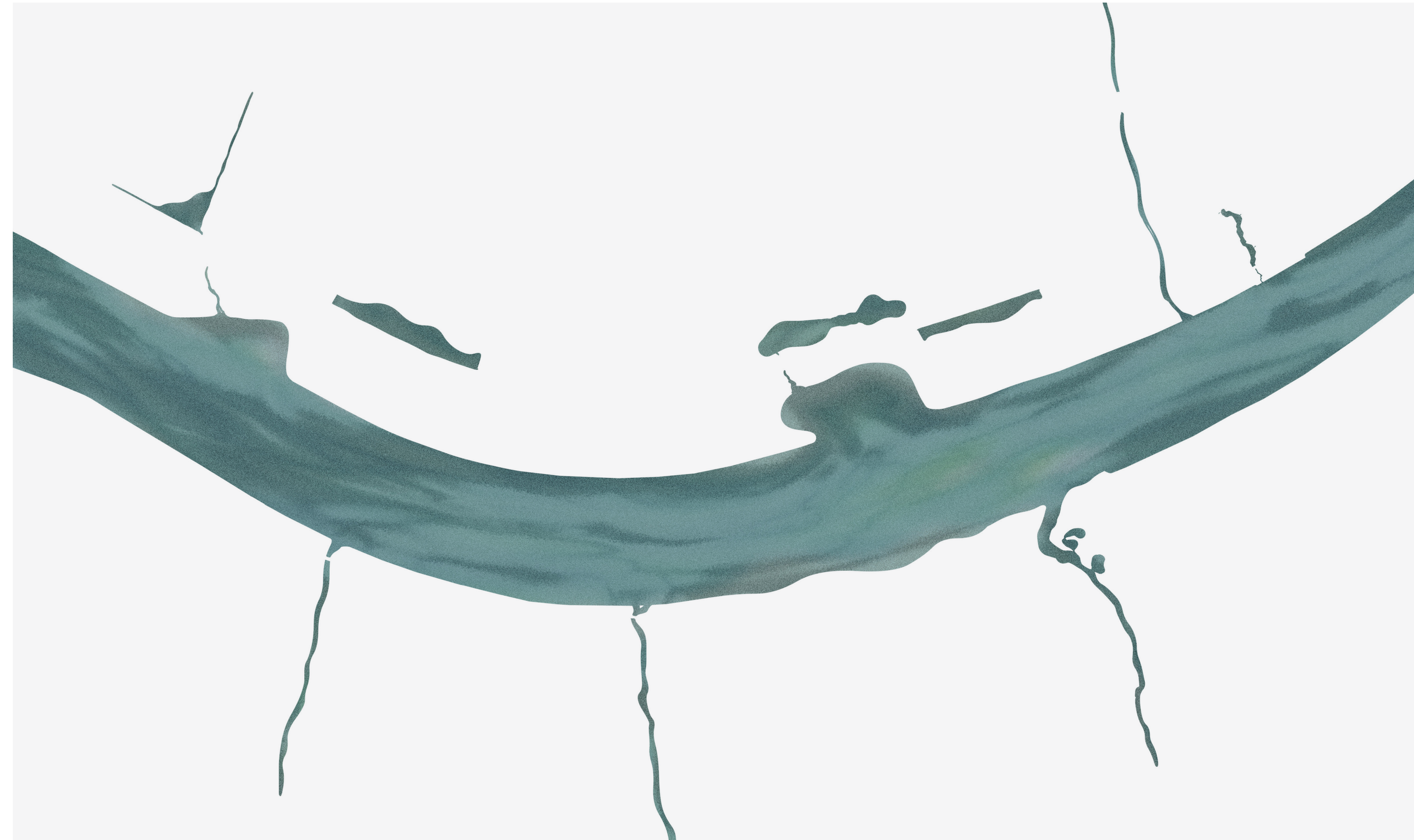

- NIEDRIGWASSER_Z426.2MÜM
- MITTELWASSER_Z427MÜM
- KLEINESHOCHWASSER_Z428.2MÜM
- HÖCHSTESHOCHWASSER_Z428.94MÜM

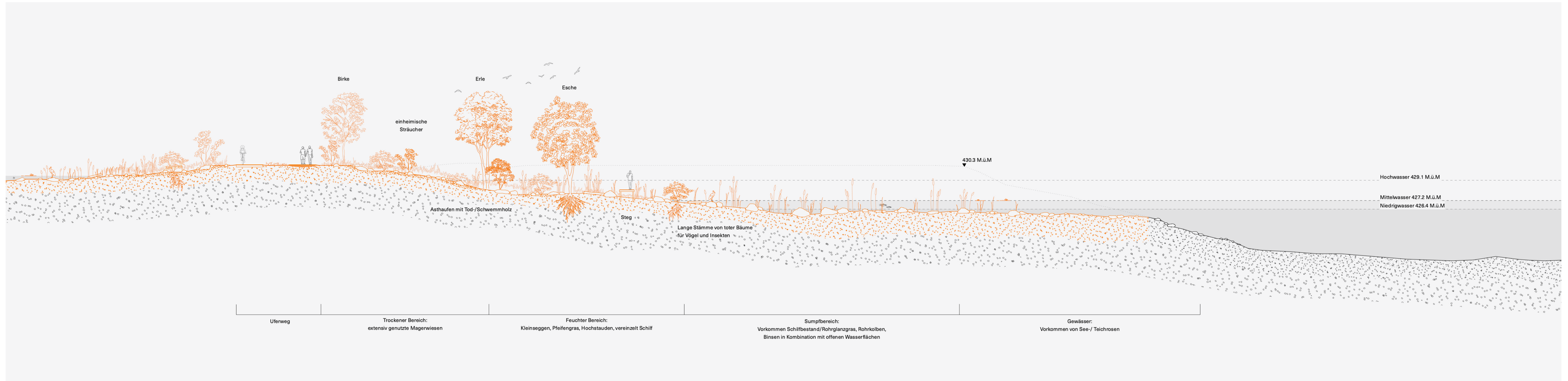
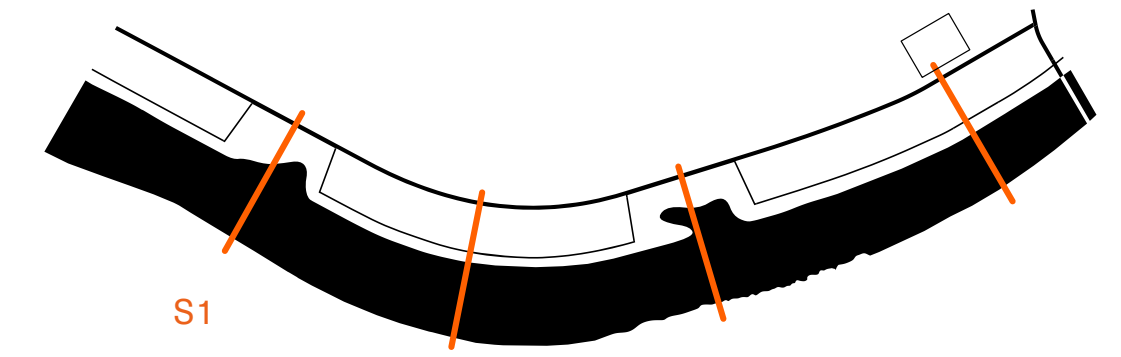

SCHNITT LANDSCHAFTSFENSTER WEST I.O. M 1:200

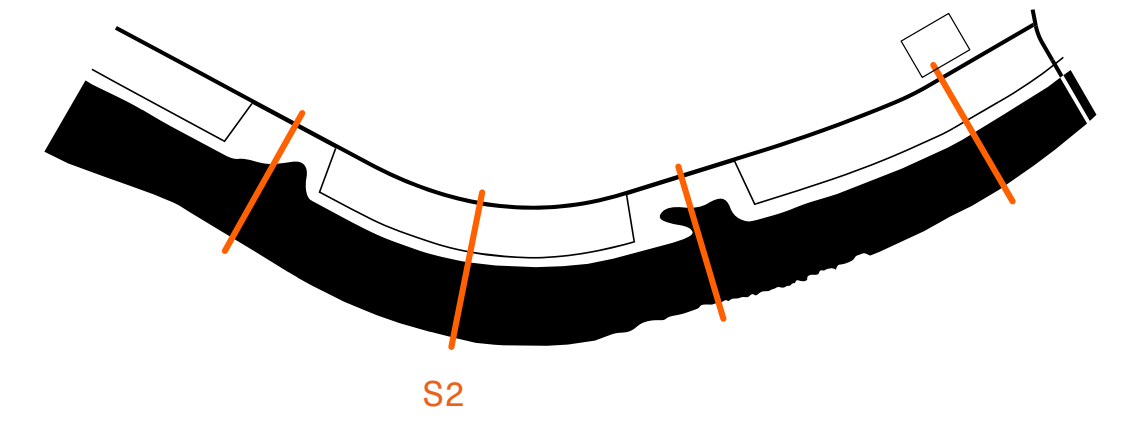

SCHNITT GÄRTEN I.O. M 1:200

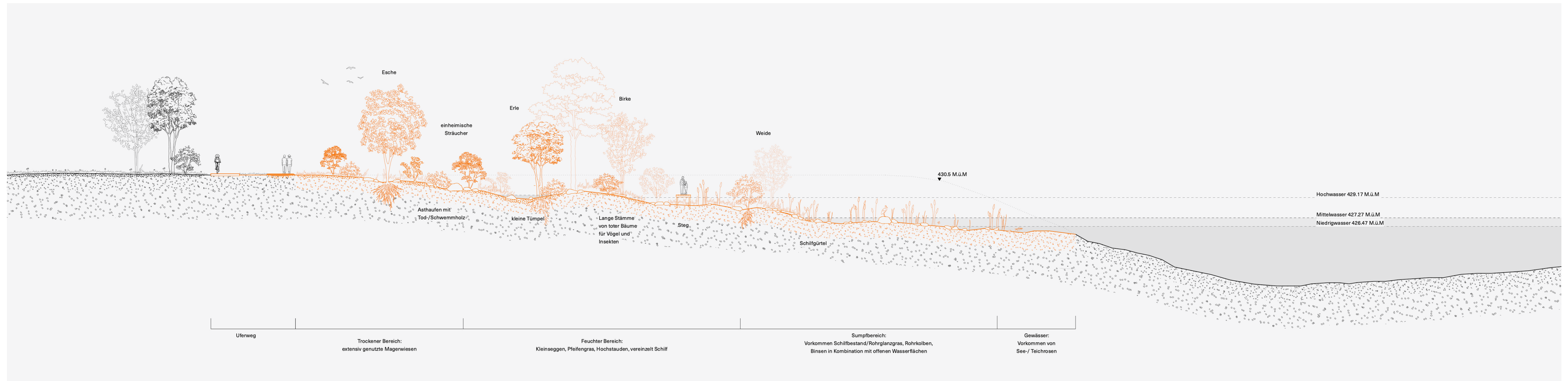
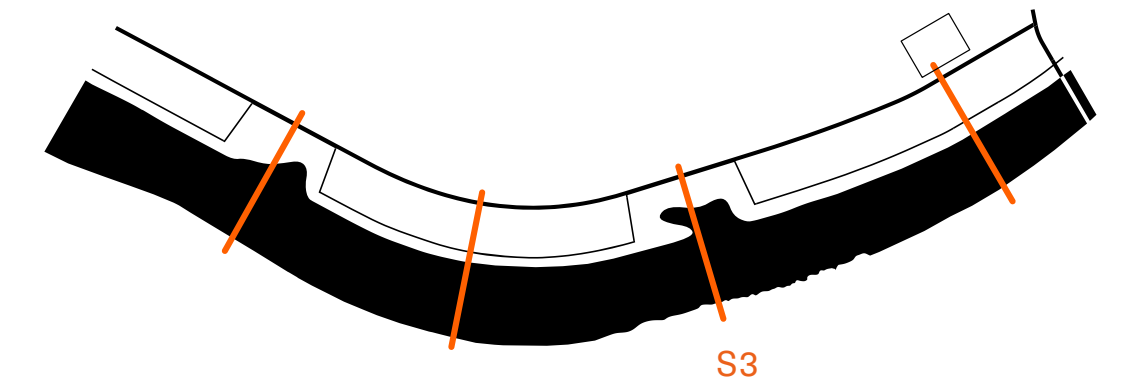

SCHNITT LANDSCHAFTSFENSTER OST I.O.M 1:200

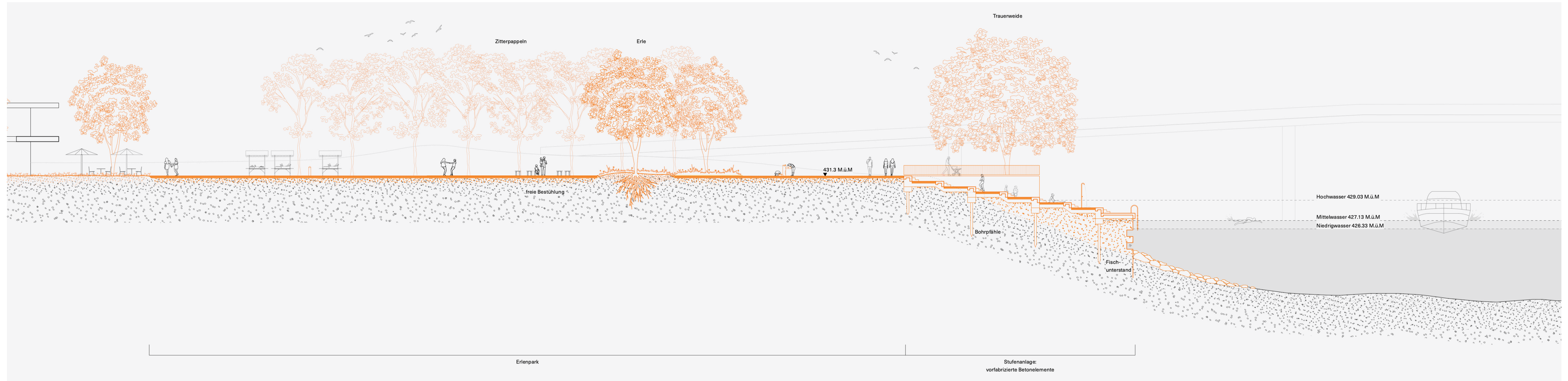
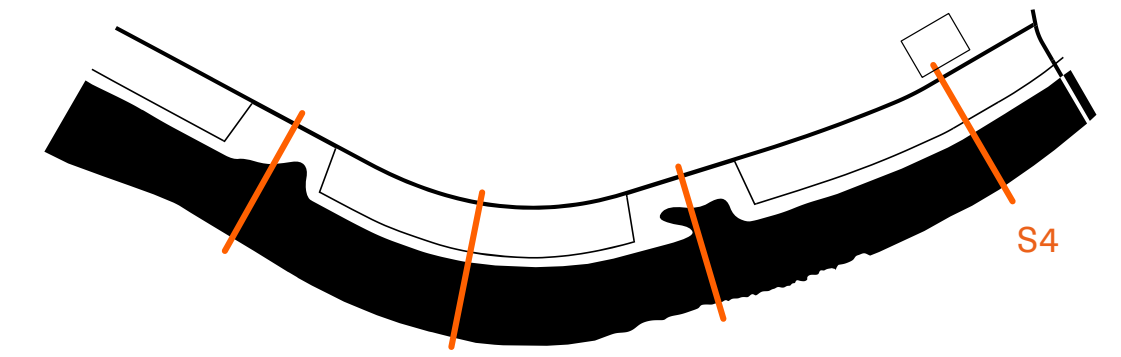

SCHNITT ERLNPARK I.O. M 1:200



VISUALISIERUNG ÖSTLICHE EINBUCHTUNG

KATALOG 1:33 Testplanung Uferparkanlage Bruggmoos

1.0 Beläge und Randabschlüsse – Jurakalk

1.1 Randabschluss – Chaussierung

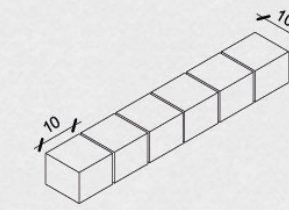

1.2 Randabschluss – Asphalt

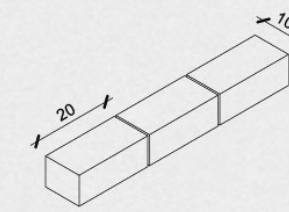

1.3 Randabschluss – Grillplatz

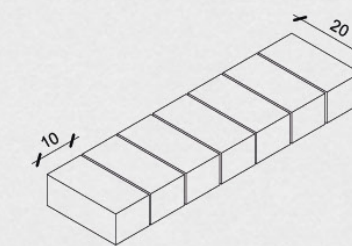

1.4 Randabschluss – Platz

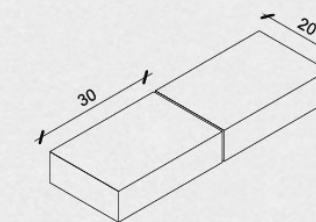

1.5 Belag - Platz

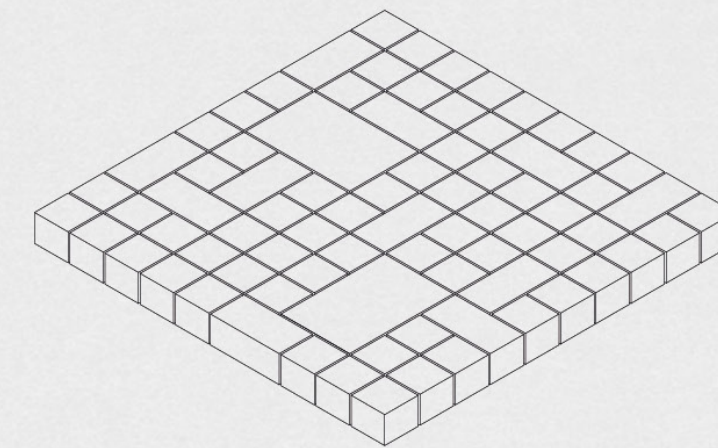

1.6 Trockensteinmauer

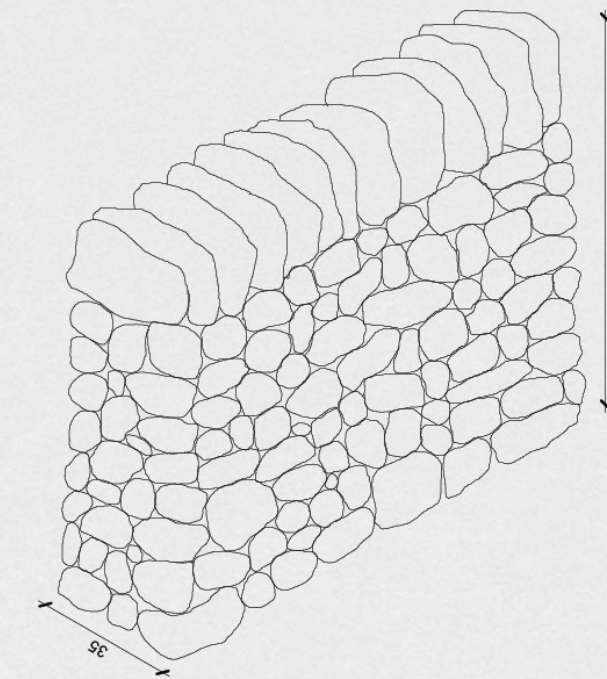

2.0 Ausstattungselemente

2.1 Freie Bestuhlung

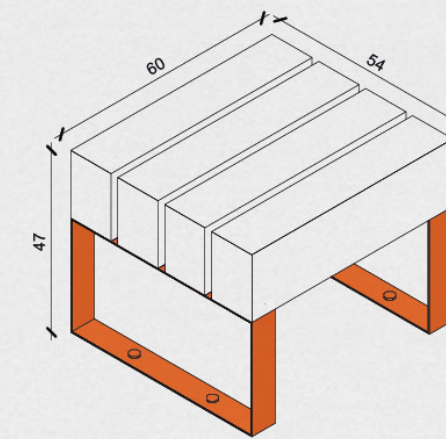

2.2 Lange Bank

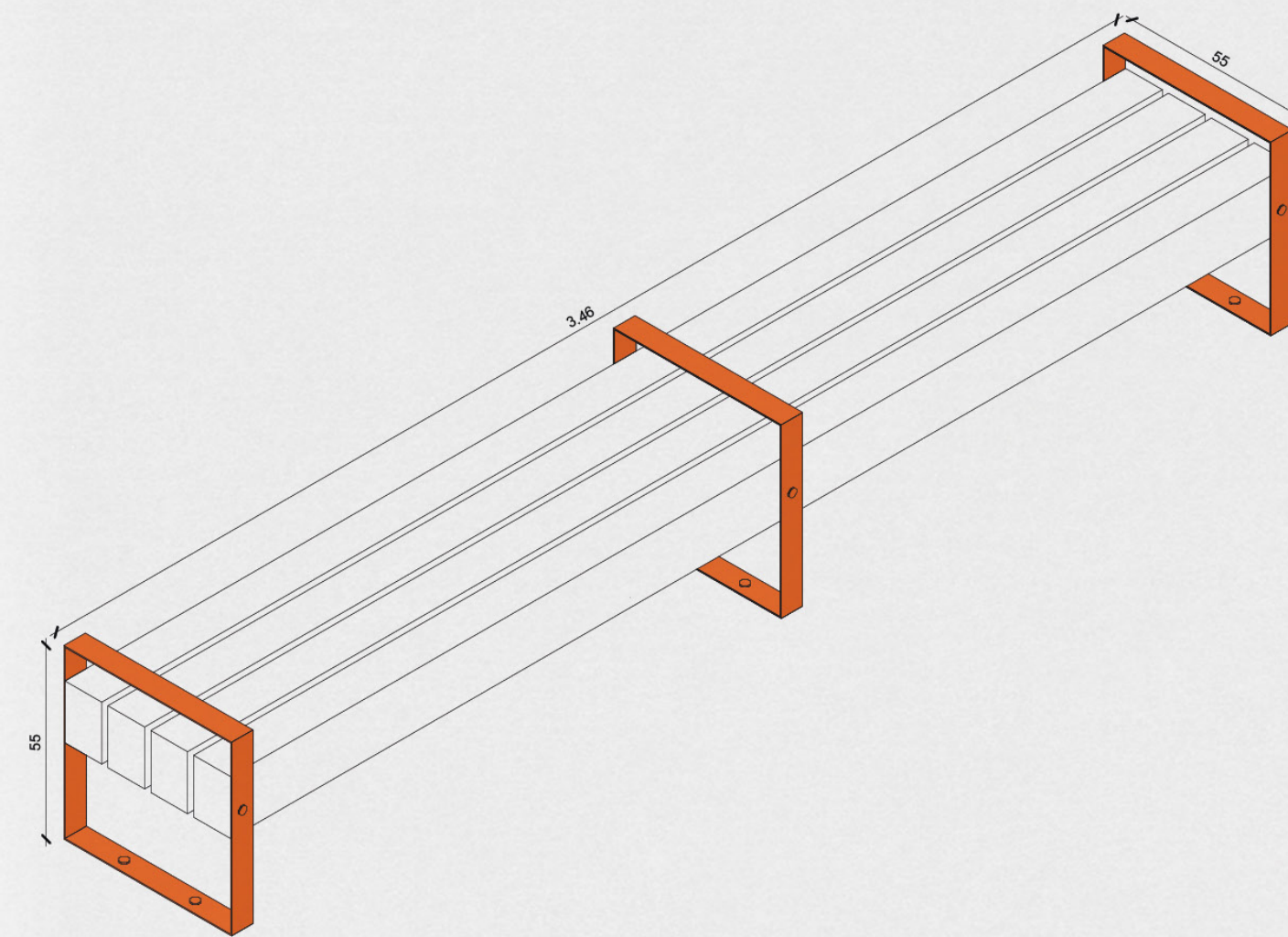

2.3 Bank mit Lehne

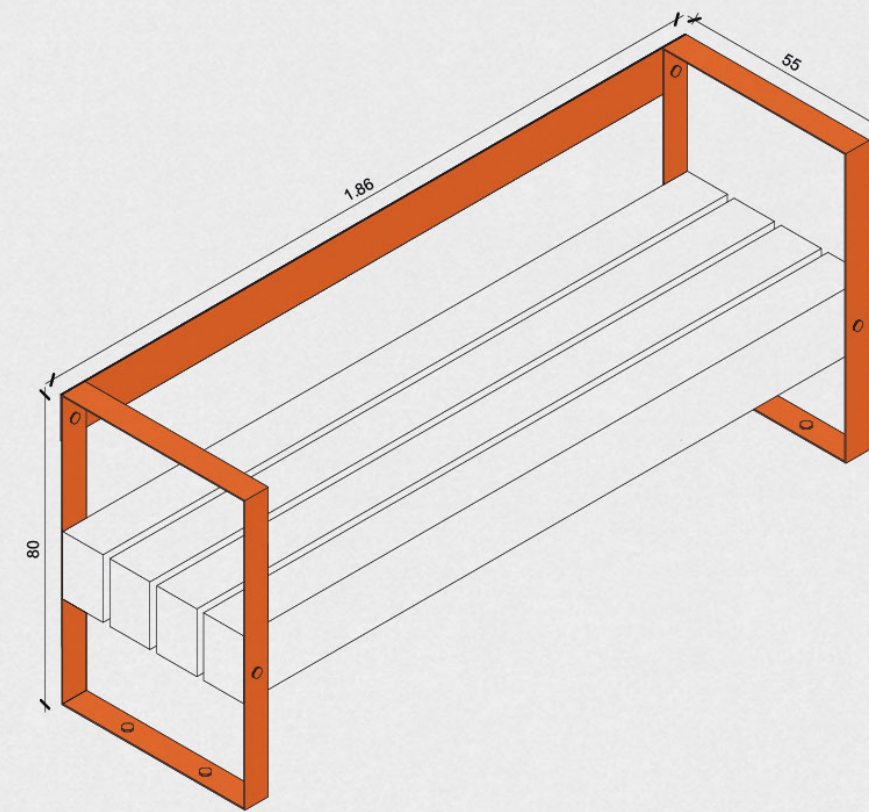

2.4 Picknick-Tisch

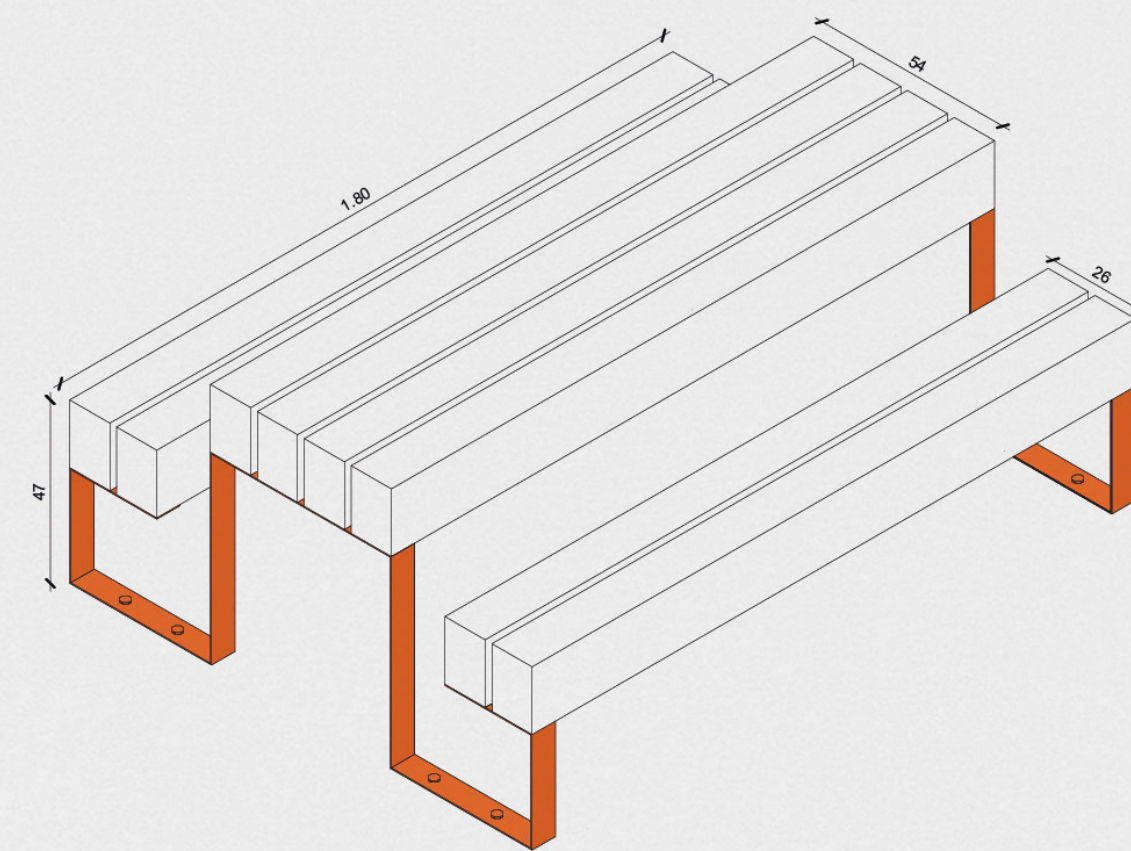

2.5 Abfallkübel

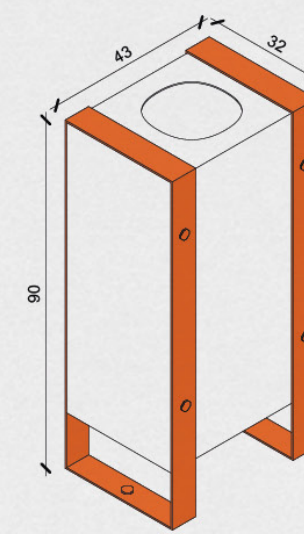

2.6 Info-Tafel

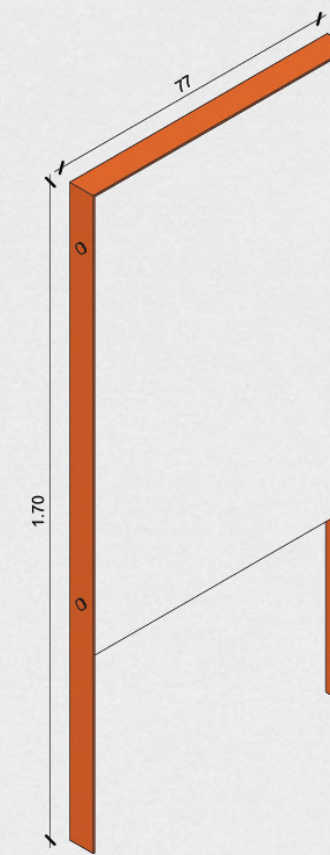

3.0 Wasserzugang

3.1 Stufenanlage Erlenpark

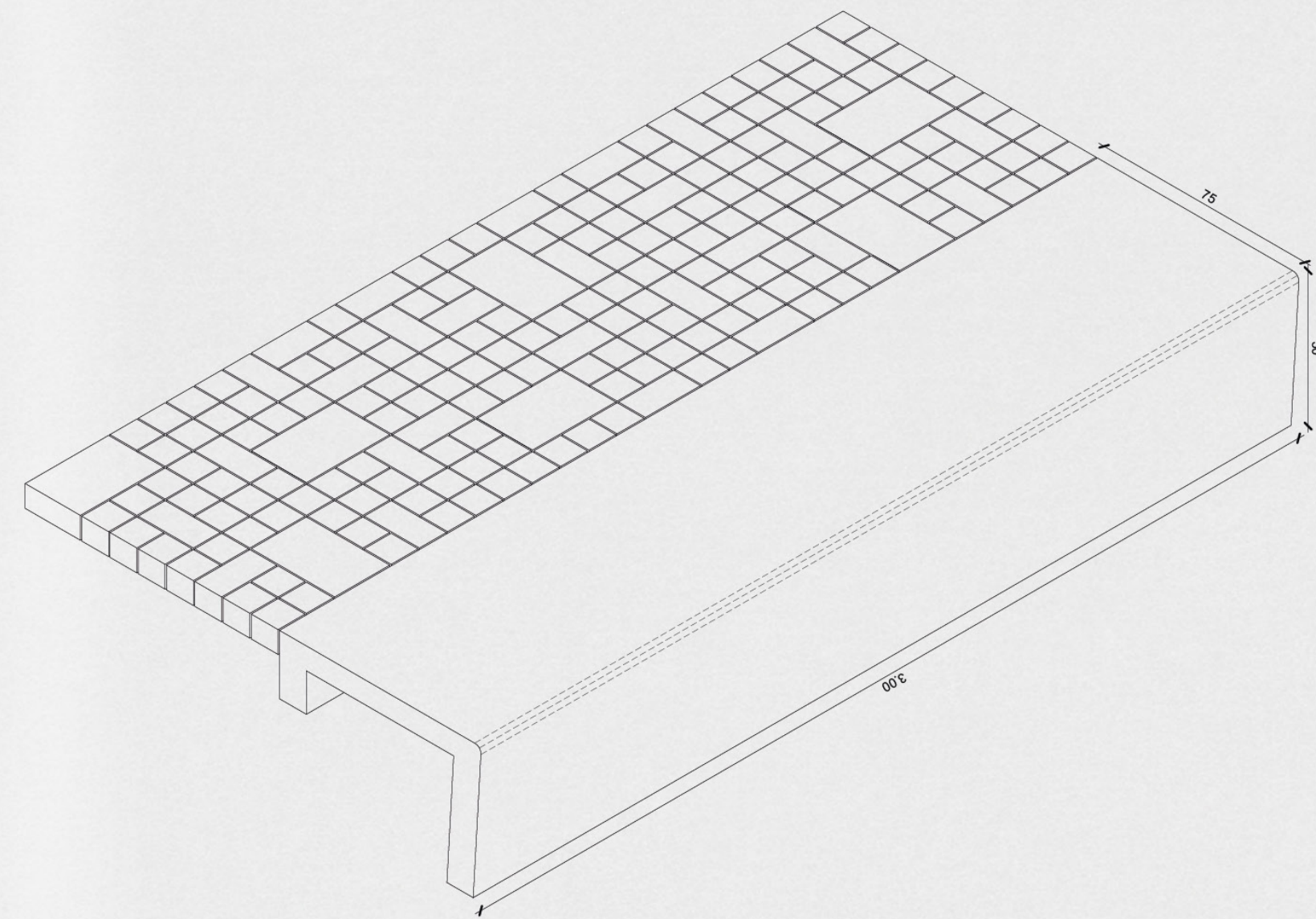

3.2 Stufenanlage Holz

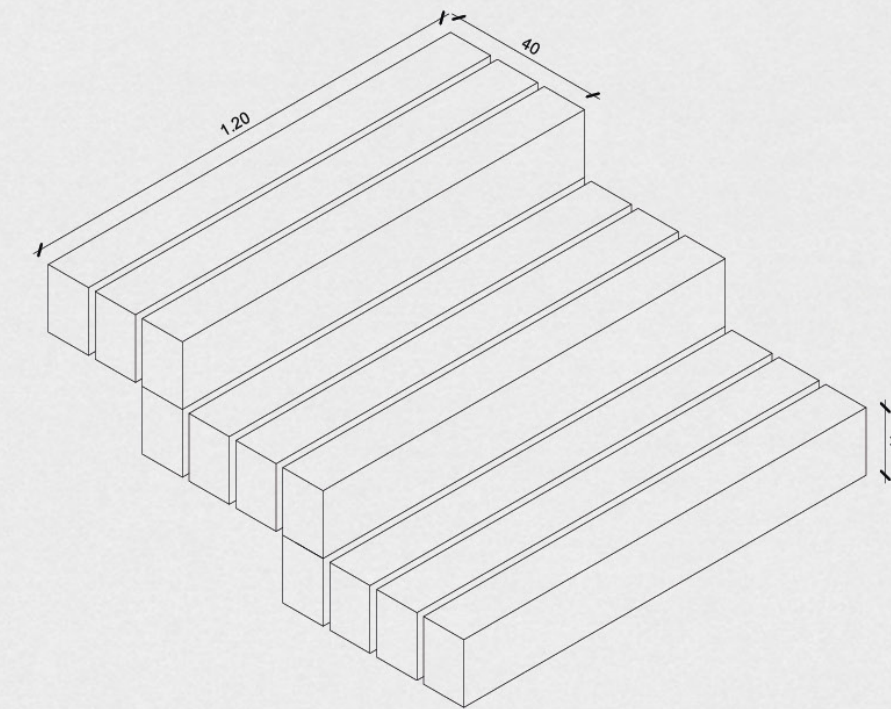

3.3 Holz-Steg

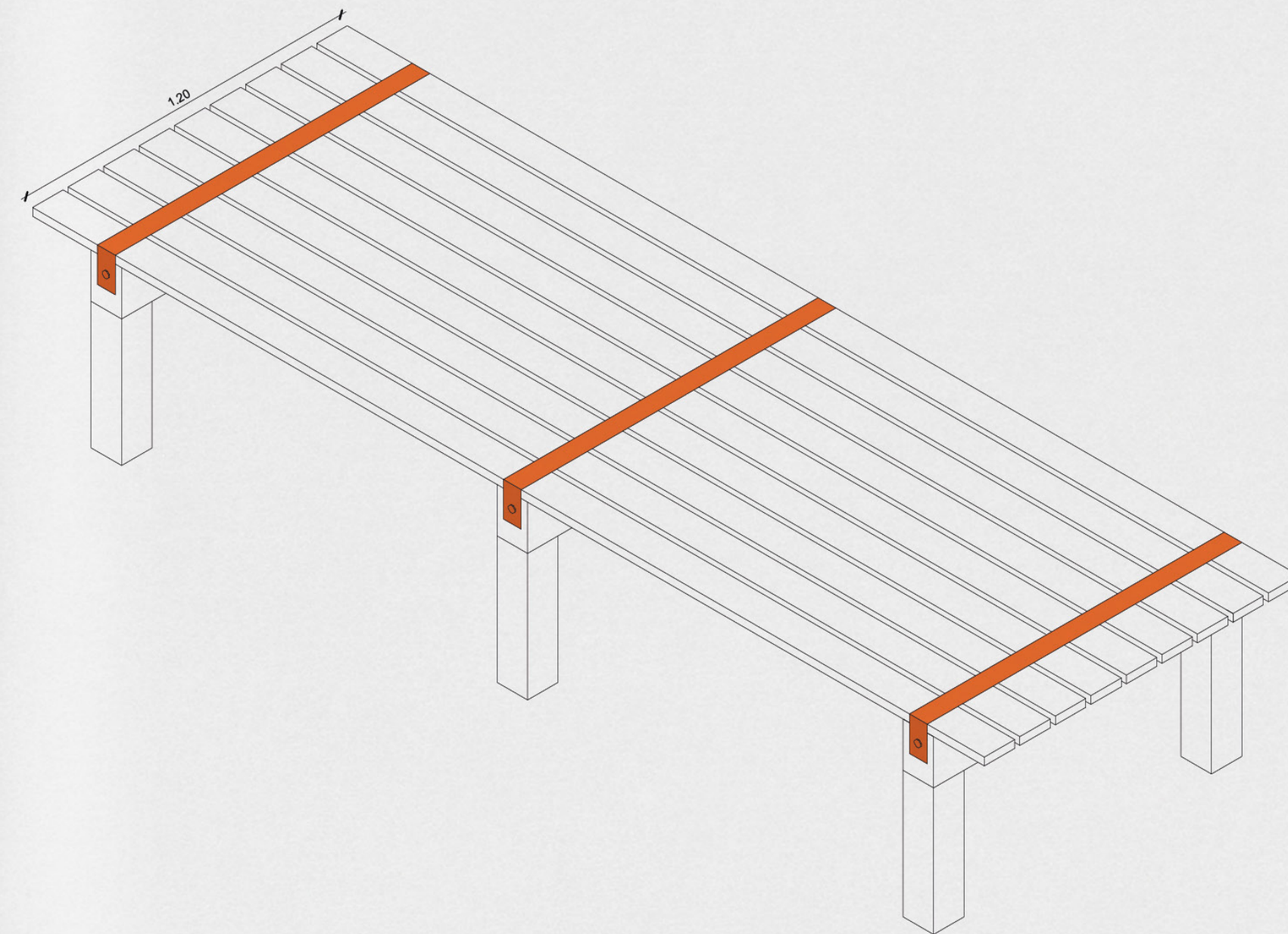

4.0 Buvette Erlenpark

offen

buvette

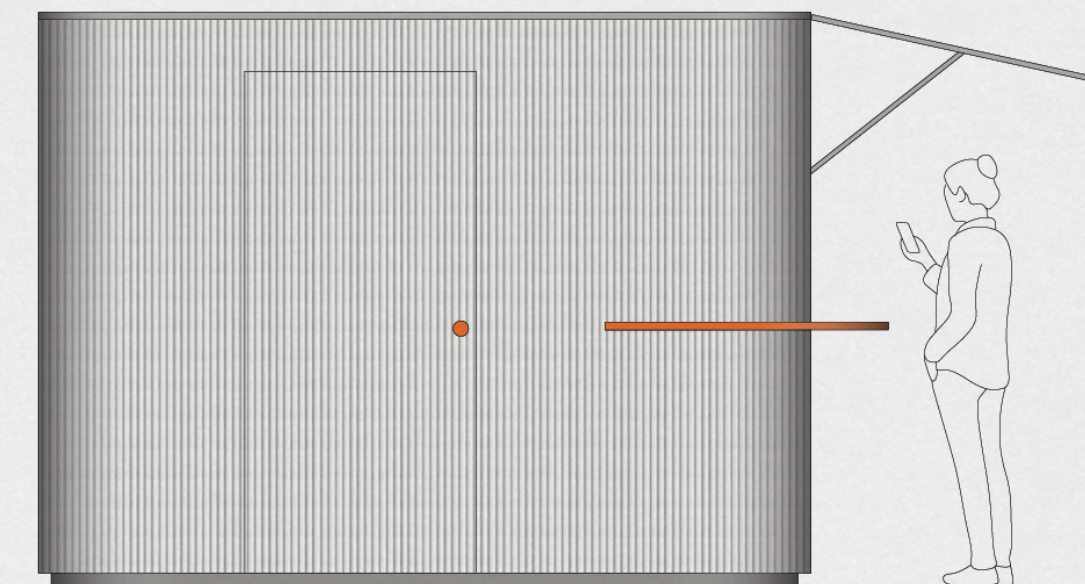

geschlossen

buvette

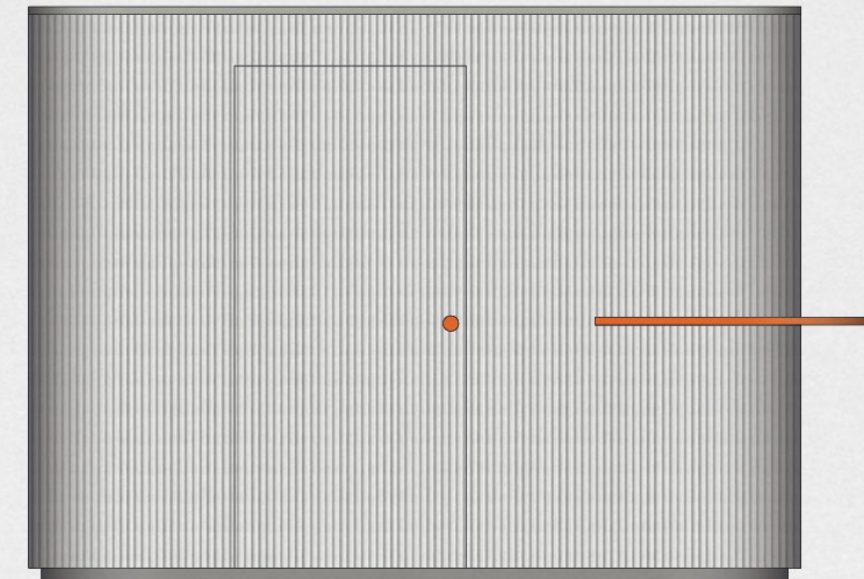
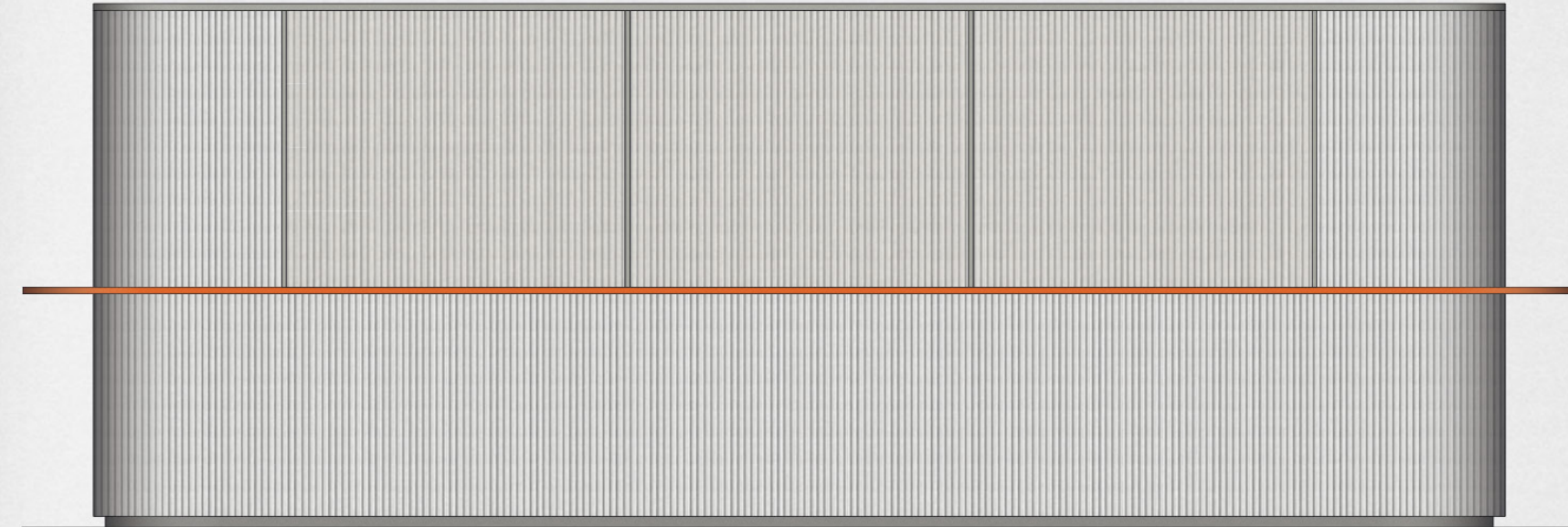

Visualisierungen

Promende

- 1.1 Randabschluss – Chaussierung
- 1.2 Randabschluss – Asphalt

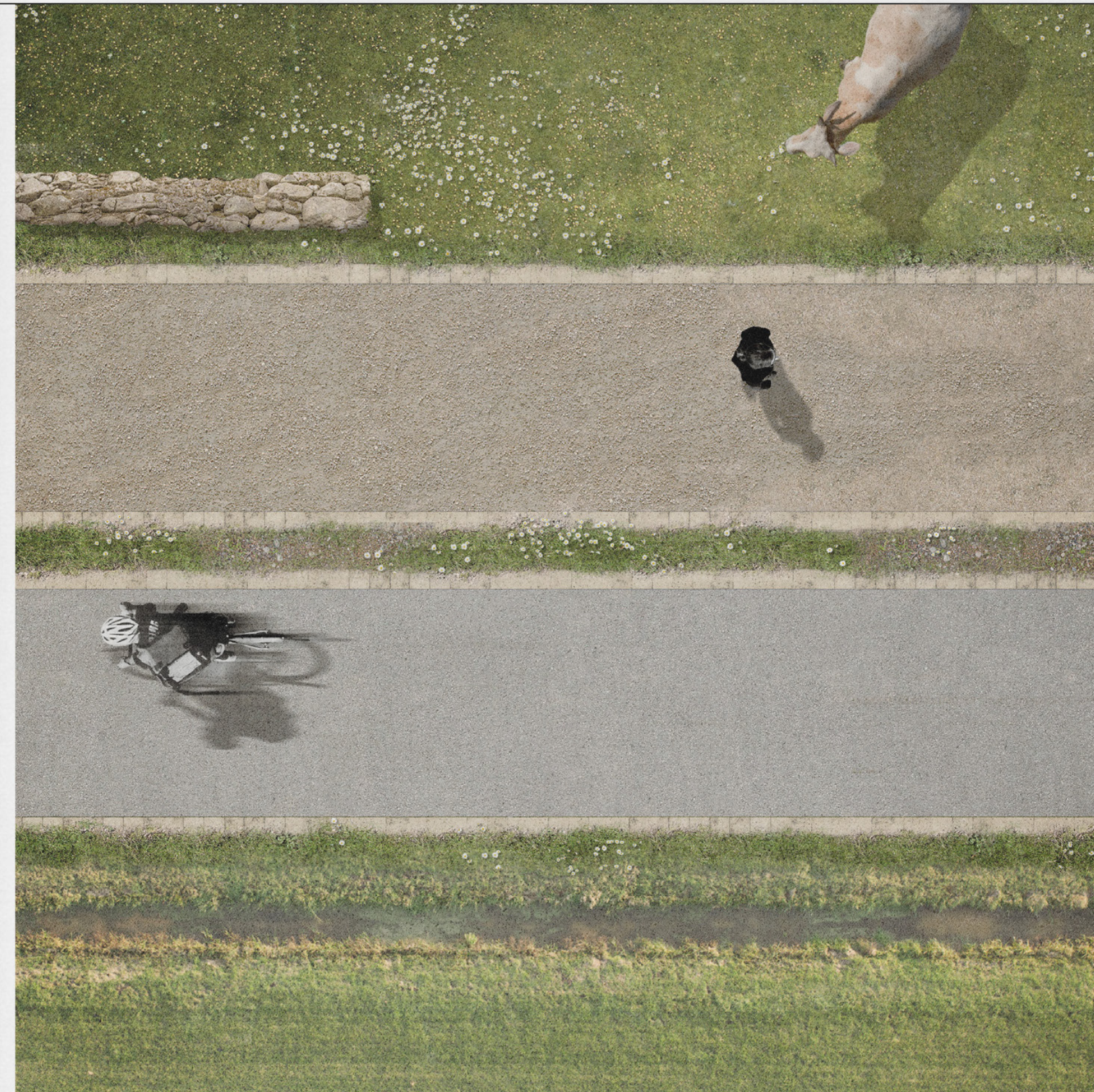

Piazza

1.4 Randabschluss – Platz
1.5 Belag – Platz



Landschaftsfenster

3.3 Holz-Steg



Steglein

3.2 Stufenanlage Holz
3.3 Holz-Steg



Ufertribüne

3.1 Stufenanlage Erlenpark



Uferweg

1.1 Randabschluss – Chaussierung



Sitzinsel am Uferweg

- 1.1 Randabschluss – Chaussierung
- 2.3 Bank mit Lehne



Sitzplatz im Blumenfeld

2.4 Picknick-Tisch



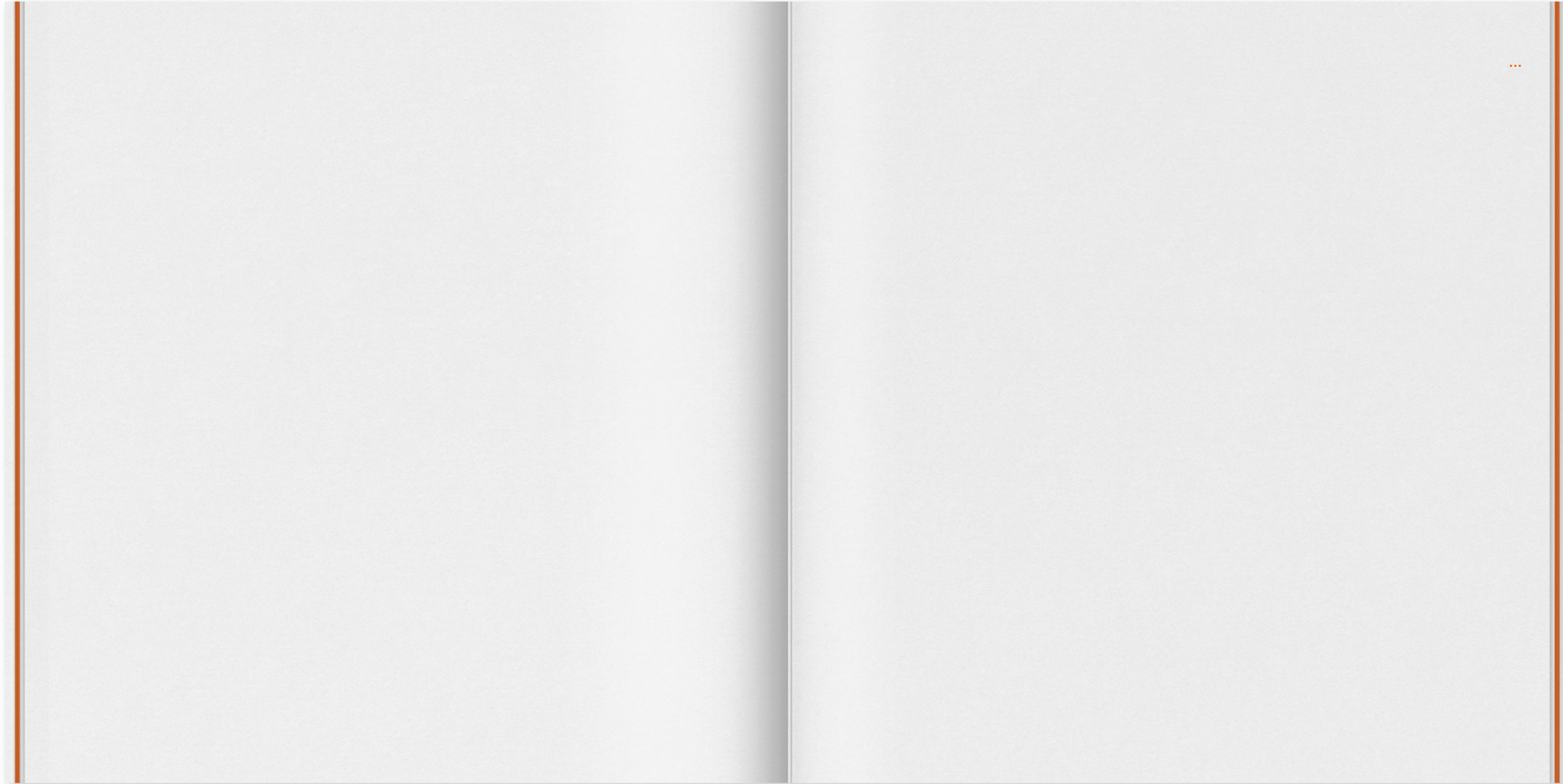

Team MOFA